

230/400/800/900MHz multi-band, Long distance, micro volume, low cost,

SDR400 Series High-speed Frequency Hopping Digital Radio

Operating Manual



SDR400 Module/Enclosed
(26.5x33x3.5/46x66x25mm,5/115g)
(2W,TTL/232/485,3.3/3.6V,9-30V)

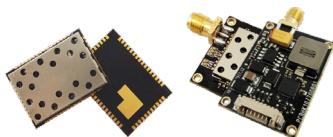

hp840/hp900
(26.5x19x2.75mm/34.5x25.5x6.5mm,2/12g)
(2Watts,CMOS/232,3.3-3.6/7-30V,2A)

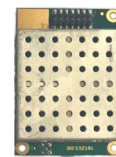

SDR400M
(65x36x13mm,25g)
(2W,232/TTL/485/422,5-25V/2A)



SDR400L Enclosed
(65x36x13/40x67x15mm,25/57g)
(2W,TTL/USB/232/485/422,5-25V/2A)



SDR400H Enclosed
(8.3x4.8x1.7/5.7x9.8x4.3cm,50/228g)
(7Watts,232/485/422,10-16V/2A)



SDR400-15/25Watts Enclosed
(10.5x8.2x3.7/10.5x7.9x4.2cm,365/451g)
(5/15/25W, 19.2-345kbps, 232/485/422, 10.5-16V/3-6A)



SDR400-Multichannel(Data, Voice, GPS)
(11.4x9.8x4.3/8.7x5.4x2.2cm,300/135g)
(19.2-345kbps,Multichannel,232/485/422,6-25V/2A)



Microhard N920 compatible



MDS EL805 compatible



Digi 9XTend compatible

SDR400 Series

Long distance, micro volume, low cost, 400/800 / 900MHz multi-band High-speed Frequency Hopping Digital Radio(Module)

The SDR400 series of high-speed FM radio(modules) based on software radio (SDR) technology provide a small, reliable and reliable remote communication solution for low-cost, space-constrained applications. The same radio(module) can be set to select the work in the 400/900MHz or 800MHz band.

400 MHz Licensed

800/900 MHz ISM

Up to 2 Watts

Extended Temperature

Dual Serial Ports

Excellent Sensitivity

Weights only 5 grams!



1.3"x1.05"x0.13"(TTL,3.3/3.6V)



SDR400 Enclosed

46x66x25mm, 120g (2W, 232/485, 9-30V)

SDR400 series of high-speed frequency hopping digital radio (module) with long-range, high-speed reliable, low latency and secure data communication advantages. Supports full duplex serial communication and diagnostic communication. SDR400 series of high-speed frequency hopping digital radio (module) has a very high noise suppression, jamming exclusion and flexible frequency synthesis, digital modulation and matched filter detection technology.

SDR400 series of high-speed frequency hopping digital radio (module) super-class performance and technical indicators, excellent resistance to electromagnetic jamming and reliable communication capabilities and advanced encryption communication function, is the industry's leading super digital transmission products.

SDR400 Features

- Point-to-point, point-to-multipoint, TDMA, store forwarding, roaming
- The software can be set to select the 400 / 900MHz or 800MHz operating frequency band
- Air speed up to 345kbps (@ 900MHz)
- Ultra low noise and jamming suppression 4-level filtering
- Transmit power 2 W / 5 W / 25 W (adjustable)
- 32-bit CRC with retransmission, selectable forward error correction
- Independent diagnostic port - real-time remote diagnostics and wireless network control
- Low power consumption of sleep and perception modes
- Industrial temperature range
- Very small size
- Aviation, military grade connection plug package options
- Compatible with Microhard N920F
- Compatible with PCC, Trimble, Satel GNSS / RTK data link protocol

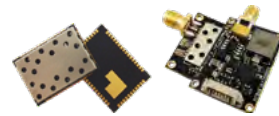

hp840/hp900
(26.5x19x2.75/34.5x25.5x6.5mm, 2/12g)
(2Watts, CMOS/232, 3.3-3.6/7-30V, 2A)



SDR400M
(65x36x13mm, 25g)
(2Watts, 232/TTL/485/422, 5-25V/2A)



SDR400L Enclosed
(65x36x13/40x67x15mm, 25/57g)
(2Watts, TTL/USB/232/485/422, 5-25V/2A)



SDR400H Enclosed
(8.3x4.8x1.7/5.7x9.8x4.3cm, 50/228g)
(7Watts, 232/485/422, 10-16V/2A)



SDR400-10/25Watts Enclosed
(9.1x6x2.1/10.5x8.2x3.7/10.5x7.9x4.2cm, 156/365g)
(5/15/25W, 19.2-345kbps, 232/485/422, 9-16V/10.5-16V/3-6A) (19.2-345kbps, Multichannel, 232/485/422, 6-25V/2A)



SDR400-Multichannel (data, voice, GPS)
(11.4x9.8x4.3/8.7x5.4x2.2mm, 300/135g)



Microhard N920 compatible



MDS EL805 compatible



Digi 9XTend compatible

SDR400 Series

Specifications

Frequency	410-480MHz/840-845MHz/902-928MHz	Frequency 410 to 480MHz(Licensed Band)				
Spreading Method/ Modulation Scheme	Frequency Hopping GMSK,2GFSK,4GFSK,QPSK	Rate(kbps)	power	Sensitivity(dBm)	Bandwidth (kHz)	Regulatory
Forward Error Correction	Hamming,BCH,Golay,Reed-Solomon,Viterbi	3.6	2W	-118	6.25	FCC/IC/CE
Error Detection	32 bits of CRC,ARQ	4.8	2W	-117	12.5	FCC/IC/CE
Encryption	Optional(see-AES option)	9.6	2W	-115	12.5	FCC/IC/CE
Serial Interface	3.3V CMOS,RS232/485(Selectable)	19.2	2W	-114	25	IC/CE
Serial Baud Rate	300bps to 230.4kbps	Frequency 410 to 480MHz(Frequency Hopping)				
Operating Modes	Point-to-Point,Point-to-Multipoint, TDMA,Store&For-ward Repeater, Peer-to-Peer	56	2W**	-113	60	None*
Signals Interface	RSSI LEDs,Tx/Rx LEDs,Reset ,Config, Wake-up,RSmode,4 Digital Inputs/ Outputs,1Analog Input,1Analog Output	115.2	2W**	-109	150	None*
Remote Diagnostics	Battery Voltage,Temperature,RSSI, Packet Statistics	172.8	2W**	-108	180	None*
Rejection	Adjacent Channel @ 400 MHz:60 dB Alternate Channel @ 400 MHz:70 dB Adjacent Channel @ 900 MHz:57 dB Alternate Channel @ 900 MHz:65 dB	230.4	2W**	-106	230	None*
Core Voltage	3.3VDC is required for 1W 3.6VDC is required for 2W	276.4	2W**	-105	230	None*
Power Consumption (3.3V)	Sleep: <1mA(Future) Idle: 20mA Rx: 45mA to 98mA Tx Peak: 2A	345	2W**	-103	400	None*
Connectors	Antenna:UFL Data :80 Pin SMT	Frequency 840-845/902-928MHz(Frequency Hopping)				
Environmental	-55°C ~+85°C 5~95% humidity,non-condensing	19.2	1W	-116	25	FCC/IC
Weight	Approx. 5 grams	56	1W	-113	60	FCC/IC
Dimensions	Approx. 1.05"x1.3"x.13" (26.5mm x 33mm x 3.5mm)	115.2	1W	-109	150	FCC/IC
Approvals	FCC Part 15.247 Pending IC RSS210 Pending FCC Part 15.90 Pending IC RSS119 Pending CE Pending	172.8	1W	-108	180	FCC/IC
		230.4	1W	-106	230	FCC/IC
		276.4	1W	-105	230	FCC/IC
		345	1W	-103	400	FCC/IC
		19.2	2W**	-115	25	None*
		56	2W**	-110	60	None*
		115.2	2W**	-109	150	None*
		172.8	2W**	-108	180	None*
		230.4	2W**	-106	230	None*
		276.4	2W**	-105	230	None*
		345	2W**	-103	400	None*
		Order Options				
		SDR400	Base Model(1W 900MHz FHSS & 2W 400MHz Narrow-band Operation)			
		-840	840-845MHz Frequency Hopping & Single Channel			
		-AES	128-bit AES Encryption			
		-C1S	1W @ 900MHz,400MHz Hopping & 2W 400MHz Licenced & 128-bit AES			
		-C2S	2W @ 900MHz,400MHz Hopping & 2W 400MHz Licenced & 128-bit AES			



Shenzhen Sinosun Technology Co.,Ltd.

Address: Room 3A17, South Cangsong Building, Tairan Science Park,Futian District, Shenzhen City, Guangdong Province, P. R. China.
 WWW.SINOSUN.CN Postcode: 518040 Phone: +86 755 83849417 83435240 Fax: +86 755 83849434 E-mail: 13823678436@139.com
 Johnson(Technical): +86 13902912908(Moblie&WeChat) +852 44017395(Moblie&WhatsApp) Dubai(UAE) Office: +971 568628869
 Tony(Sales): +86 13823678436(Moblie&WeChat) +852 53721462(Moblie&WhatsApp)

Table of Contents

1.0	Overview	13
1.1	Performance Features	13
1.2	Specifications	14
2.0	Hardware Description	16
2.1	Mechanical Drawing	17
2.1.1	Recommended Solder Mask (Pad Landing)	18
2.1.2	Recommended Solder Paste Pattern.....	19
2.1.3	SMT Temperature Profile	20
2.2	OEM Connectors	20
2.3	Pin Descriptions	21
2.4	Minimum Connection Requirements	22
2.5	Electrical Characteristics	25
2.5.1	Test Conditions	25
2.5.1.1	Minimum and Maximum Values	25
2.5.1.2	Typical Values.....	25
2.5.1.3	Loading Capacitor	25
2.5.1.4	Pin Input Voltage	25
2.5.2	Absolute Maximum Ratings	26
2.5.3	Operating Conditions	26
2.5.3.1	Operating Conditions at Power-up / Power-down	26
2.5.3.2	Voltage Characteristics	26
2.5.3.3	Current Characteristics	27
2.5.3.4	IO Port Characteristics.....	27
2.5.3.5	12-bit ADC Characteristics.....	29
2.6	SDR400 to n920 Pin-outs	31
2.7	SDR400 Enclosed	32
2.7.1	SDR400 Enclosed Dimensional Drawings	33
2.7.2	SDR400-ENC Mounting Bracket (Optional).....	34
2.7.3	Connectors & Indicators.....	35
3.0	400 MHz Licensed Band Configuration	37
3.1	Configuration/Unit Modes	37
3.1.1	Command Mode	37
3.1.2	Data mode.....	38
3.1.3	Modem Type (S128=0)	39
3.1.3.1	Call Sign ID	39
3.1.4	Factory Default Settings.....	40
3.2	Microhard Transparent Mode	41
3.2.1	Transparent Mode Factory Defaults.....	42
3.2.2	Modulation & Link Rate Considerations	43
3.3	Pacific Crest (PCC) models	44
3.4	Trimble (Trintalk) Models	46
3.5	Satel (3AS) Models	48
4.0	900 MHz Frequency Hopping Configuration	50
4.1	Configuration/Unit Modes	50
4.1.1	Command Mode	50
4.1.2	Data mode.....	51
4.1.3	Modem Type (S128=1)	52
4.1.4	Network Type	52
4.1.5	900 MHz Frequency Hopping.....	53

Table of Contents (continued)

4.2	Point to Point Network	54
4.2.1	Operating Modes / Unit Types	54
4.2.2	Configuration Using Factory Defaults.....	56
	AT&F6 - PP Master.....	57
	AT&F7 - PP Slave/Remote.....	58
	PP Repeater.....	59
4.2.3	Retransmissions	60
4.2.4	Network Synchronization.....	60
4.3	Point to Multipoint Network	61
4.3.1	Operating Modes / Unit Types	61
4.3.2	Configuration Using Factory Defaults.....	64
	AT&F1 - PMP Master.....	65
	AT&F2 - PMP Slave/Remote.....	66
	AT&F3 - PMP Repeater	67
4.3.3	Unit Addressing	68
4.3.4	Retransmissions	68
4.3.5	Network Synchronization.....	68
4.3.6	TDMA.....	69
4.3.7	Peer-to-Peer.....	71
4.3.8	Everyone-to-Everyone	72
5.0	400 MHz Frequency Hopping Configuration	73
5.1	Configuration/Unit Modes	73
5.1.1	Command Mode	73
5.1.2	Data mode.....	74
5.1.3	Modem Type (S128=2)	75
5.1.4	Network Type	75
5.1.5	Hopping On Frequency Table.....	76
	5.1.5.1 Frequency Table	76
	5.1.5.2 ATP0 and APT1 Commands.....	76
5.2	Point to Point Network	79
5.2.1	Operating Modes / Unit Types	79
5.2.2	Configuration Using Factory Defaults.....	81
	AT&F6 - PP Master.....	82
	AT&F7 - PP Slave/Remote.....	83
	PP Repeater.....	84
5.2.3	Retransmissions	85
5.2.4	Network Synchronization.....	85
5.3	Point to Multipoint Network	86
5.3.1	Operating Modes / Unit Types	86
5.3.2	Configuration Using Factory Defaults.....	89
	AT&F1 - PMP Master.....	90
	AT&F2 - PMP Slave/Remote.....	91
	AT&F3 - PMP Repeater	92
5.3.3	Unit Addressing	93
5.3.4	Retransmissions	93
5.3.5	Network Synchronization.....	93
5.3.6	TDMA.....	94
5.3.7	Peer-to-Peer.....	96
5.3.8	Everyone-to-Everyone	97

Table of Contents (continued)

6.0	Register/Command Reference	98
6.1	AT Commands	98
A	Answer	98
g, G	Spectrum Analyzer	98
In	Identification	98
Login	AT Login	99
N	Advanced Spectrum Analyzer	99
&Fn	Load Factory Default Configuration	100
&H0	Frequency Restriction (FHSS)	101
&H1	Repeater Registration (FHSS)	102
&V	View Configuration	102
&W	Write Configuration to Memory	102
&P0/P1	Frequency Table (400 MHz)	103
6.2	Settings (S) Registers	104
S0	Power Up Mode	104
S2	Escape Code	104
S51	RSSI Threshold (NB)	104
S101	Operating Mode	105
S102	Serial Baud Rate	105
S103	Wireless Link Rate	105
S104	Network ID/Address (FH)	106
S105	Unit Address	106
S107	Static Mask	106
S108	Output Power	106
S109	Hop Interval (FH)	107
S110	Data Format	107
S111	Packet Min Size	108
S112	Packet Max Size	108
S113	Packet Retransmissions	108
S115	Repeat Interval (FH)	108
S116	Character Timeout	109
S118	Roaming (FH)	109
S119	Quick Enter to Command Mode	109
S123	RSSI from Uplink/Master (dBm)	110
S124	RSSI from Downlink/Slave (dBm)	110
S125	Occupied Bandwidth (NB)	110
S127	Modulation (NB)	110
S128	Modem Type	110
S129	Full CRC Use (3AS)	111
S130	No Sync Intake	111
S131	Main Tx Frequency (NB)	111
S132	Main Rx Frequency (NB)	111
S133	Network Type	111
S136	TX_RX Priority (NB)	111
S137	CSMA Time Slot Size (NB)	112
S138	After Tx Delay (NB)	112
S139	Compatible_921 at 345 (900MHz)	112
S140	Destination Address	112
S141	Repeaters Y/N	112
S142	Serial Channel Mode (RS232/485)	112
S150	Sync Mode (FH)	113
S151	Fast Sync Timeout (FH)	113
S153	Address Tag (FH)	113
S158	Forward Error Correction (FEC) Mode	114

Table of Contents (continued)

S163	CRC Check on Diag Port.....	114
S167	Tx Enable	114
S185	Tx Attack Delay (NB).....	115
S186	Protocol Selection (NB).....	115
S187	Disc.Dupl.Downstr.Dat (Trimtalk).....	115
S188	Strip Off Additional Data (Trimtalk).....	115
S189	Enable Uplink (Trimtalk).....	115
S190	Ignore Received UA (Pacific Crest).....	116
S191	Repeater Tx Frequency.....	116
S192	Repeater Rx Frequency	116
S213	Packet Retry Limit.....	116
S214	Diagnostics Packet Retransmission	116
S217	Protocol Type (FH).....	116
S223	Minimum RSSI.....	117
S224	Maximum RSSI	117
S226	Compatibility Type (NB).....	117
S227	Trimtalk Comp. Type. (Trimtalk).....	117
S231	Data Buffering Mode (NB)	117
S238	Hopping Mode	117
S244	Channel Access Mode (FH).....	118
S248	Sync Timeout (FH).....	118
S251	Master Hop Allocation Timeout.....	118
6.3	Serial Interface Commands.....	119
&Cn	Data Carrier Detect (DCD).....	119
&Dn	Data Terminal Ready (DTR)	119
&K	Handshaking.....	119
&Sn	Data Set Ready (DSR)	119
7.0	Installation	120
7.1	Path Calculation.....	122
7.2	Installation of Antenna System Components.....	123
7.2.1	Antennas	124
7.2.2	Coaxial Cable	124
7.2.3	Surge Arrestors.....	124
7.2.4	External Filter.....	124
Appendices		
Appendix A:	AT Command Quick Reference	125
Appendix B:	Settings (S) Register Quick Reference.....	126
Appendix C:	AT Utility Firmware Upgrade.....	127
Appendix D:	AT Command Firmware Upgrade	128
Appendix E:	Development Board Serial Interface.....	129
Appendix F:	Development Board Schematic.....	130
Appendix G:	Approved Antennas.....	131
Appendix H:	Antenna / Separations	132

1.0 Overview

The SDR400 Series is capable of delivering high-performance, robust and secure wireless serial communications in Point to Point or Point to Multipoint topologies.

The SDR400 Series is available as a tightly integrated OEM module, for the ultimate in design integration. When properly configured and installed, long range communications at very high speeds can be achieved.

SDR400 Series modules are a Multi-Frequency modem capable of operating as a 902-928MHz ISM FHSS Modem, a 410-480 MHz Narrowband Modem, or as a 400 MHz Frequency Hopping modem, providing flexible wireless data transfer between most equipment types which employ a serial interface. The modem type of the module is software selectable using AT commands.

The small size and superior performance of the SDR400 Series makes it ideal for many applications. Some typical uses for this modem:

- SCADA
- remote telemetry
- traffic control
- industrial controls
- remote monitoring
- fleet management
- GPS
- metering
- robotics
- display signs
- railway signaling

1.1 Performance Features

Key performance features of the SDR400 Series include:

- 902 - 928 ISM Frequency Hopping Operation (900 MHz FH Mode)
- 410 - 480 MHz Narrowband Licensed Operation (400 MHz NB Mode)
- 410 - 480 MHz Frequency Hopping Operation (400 MHz FH Mode - Order Option)
- up to 2W of output power
- transparent, low latency link rates up to 345 kbps
- communicates with virtually all serial based devices
- wide temperature specification
- 32 bits of CRC, selectable retransmission and forward error correction
- separate diagnostics port - remote diagnostics and online network control
- ease of installation and configuration - the SDR400 utilizes a subset of standard AT-style commands, similar to those used by traditional telephone line modems
- 3.3V logic level compatibility

¹902-928MHz, which is license-free within North America; may need to be factory-configured differently for some countries, contact Microhard Systems Inc. for details.

1.0 Overview

1.2 SDR400 Series

Specifications Electrical/General

Supported Frequency:	902 - 928 MHz 410 - 480 MHz Model Dependant, See Table 1-1
Spreading Method:	Frequency Hopping, GMSK, 2GFSK, 4GFSK, QPSK
Error Detection:	32 bits of CRC, ARQ
Data Encryption: (Optional)	128-bit AES Encryption (Requires export permit outside US and Canada.)
Range:	Up to 60 miles (100km)
Output Power:	Up to 2W (Model Dependant, See Table 1-1)
Sensitivity:	Model Dependant, See Table 1-1.
Link Rate:	Up to 345 kbps
Serial Baud Rate:	300 to 230.4 kbps
Core Voltage:	3.3VDC is required for 1W 3.6VDC is required for 2W
Power Consumption: (3.3VDC)	Sleep: < 1mA (Future) Idle: 20mA Rx: 45mA to 98mA Tx Peak: 2A
Rejection:	Adjacent Channel @ 400 MHz: 60dB Alternate Channel @ 400 MHz: 70dB Adjacent Channel @ 900 MHz: 57 dB Alternate Channel @ 900 MHz: 65 dB
Available Models:	SDR400 Base Model (1W 900 MHz & 2W 400 MHz Licensed)* -AES 128-bit AES Encryption** -C2S 2W 900 MHz, 2W 400 MHz Frequency Hopping, 2W 400 MHz Licensed & 128-bit AES Encryption** -C1S 1W 900 MHz, 1W 400 MHz Frequency Hopping, 2W 400 MHz Licenced & 128-bit AES** -ENC Enclosed (Standalone) Model



Caution: Using a power supply that does not provide proper voltage or current may damage the modem.

*Standard Modems are Shipped with 400MHz Licensed band operation up to 2W and 900MHz ISM FHSS operation 1W with no AES encryption. No other operation is allowed. Operating outside this requires compliance with applicability Radio Regulatory Bodies and Canadian Export Laws. Extra Cost/Activation/Proof of Regulatory Compliance is Required.

**AES encryption, 2W frequency hopping operation requires Export Permit

1.0 Overview

1.2 SDR400 Series Specifications

Rate (kbps)	Power (W)	Sensitivity (dBm)	Bandwidth (kHz)	Regulatory
Frequency 410 to 480 MHz (Licensed Band)				
3.6	2	-118	6.25	FCC/IC/CE
4.8	2	-117	12.5	FCC/IC/CE
9.6	2	-115	12.5	FCC/IC/CE
19.2	2	-114	25	IC/CE
Frequency 410 to 480 MHz (Frequency Hopping)				
56	2**	-113	60	None*
115.2	2**	-109	150	None*
172.8	2**	-108	180	None*
230.4	2**	-106	230	None*
276.4	2**	-105	400	None*
345	2**	-103	400	None*
Frequency 902 to 928 MHz (Frequency Hopping)				
19.2	1	-116	25	FCC/IC
56	1	-113	60	FCC/IC
115.2	1	-109	150	FCC/IC
172.8	1	-108	180	FCC/IC
230.4	1	-106	230	FCC/IC
276.4	1	-105	400	FCC/IC
345	1	-103	400	FCC/IC
19.2	2**	-115	25	None*
56	2**	-110	60	None*
115.2	2**	-109	150	None*
172.8	2**	-108	180	None*
230.4	2**	-106	230	None*
276.4	2**	-105	400	None*
345	2**	-103	400	None*

*Standard Modems are Shipped with 400MHz Licensed band operation up to 2W and 900MHz ISM FHSS operation 1W with no AES encryption. No other operation is allowed. Operating outside this requires compliance with applicability Radio Regulatory Bodies and Canadian Export Laws. Extra Cost/Activation/Proof of Regulatory Compliance is Required.

**AES encryption, 2W frequency hopping operation requires Export Permit

Table 1-1: SDR400 Specifications

Environmental

Operation Temperature: -40°F(-40°C) to 185°F(85°C)
Humidity: 5% to 95% non-condensing

Mechanical

Dimensions: OEM: 26.5mm X 33mm X 3.5mm ENC: 57mm X 95mm X 38mm
Weight: OEM: 5 grams ENC: 210 grams
Connectors: Antenna: OEM: UFL ENC: RP-SMA
 Data: OEM: 80 Pin/Pad SMT ENC: DB9

2.0 Hardware Description

The SDR400 Series Modem modules are available as a OEM module. This OEM version supplies all the required raw signals to allow the unit to be tightly integrated into applications to efficiently maximize space and power requirements. The Microhard development board can provide a convenient evaluation platform to test and design with the module. (Contact Microhard Systems for details)

Any SDR400 Series module may be configured as a Master, Repeater or Remote in a PTP or PMP Topology. This versatility is very convenient from a 'sparing' perspective, as well for convenience in becoming familiar and proficient with using the module: if you are familiar with one unit, you will be familiar with all units.



Image 2-1: SDR400 Series Top View

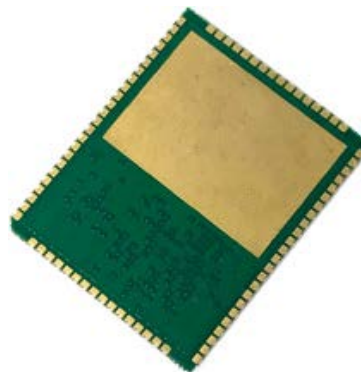
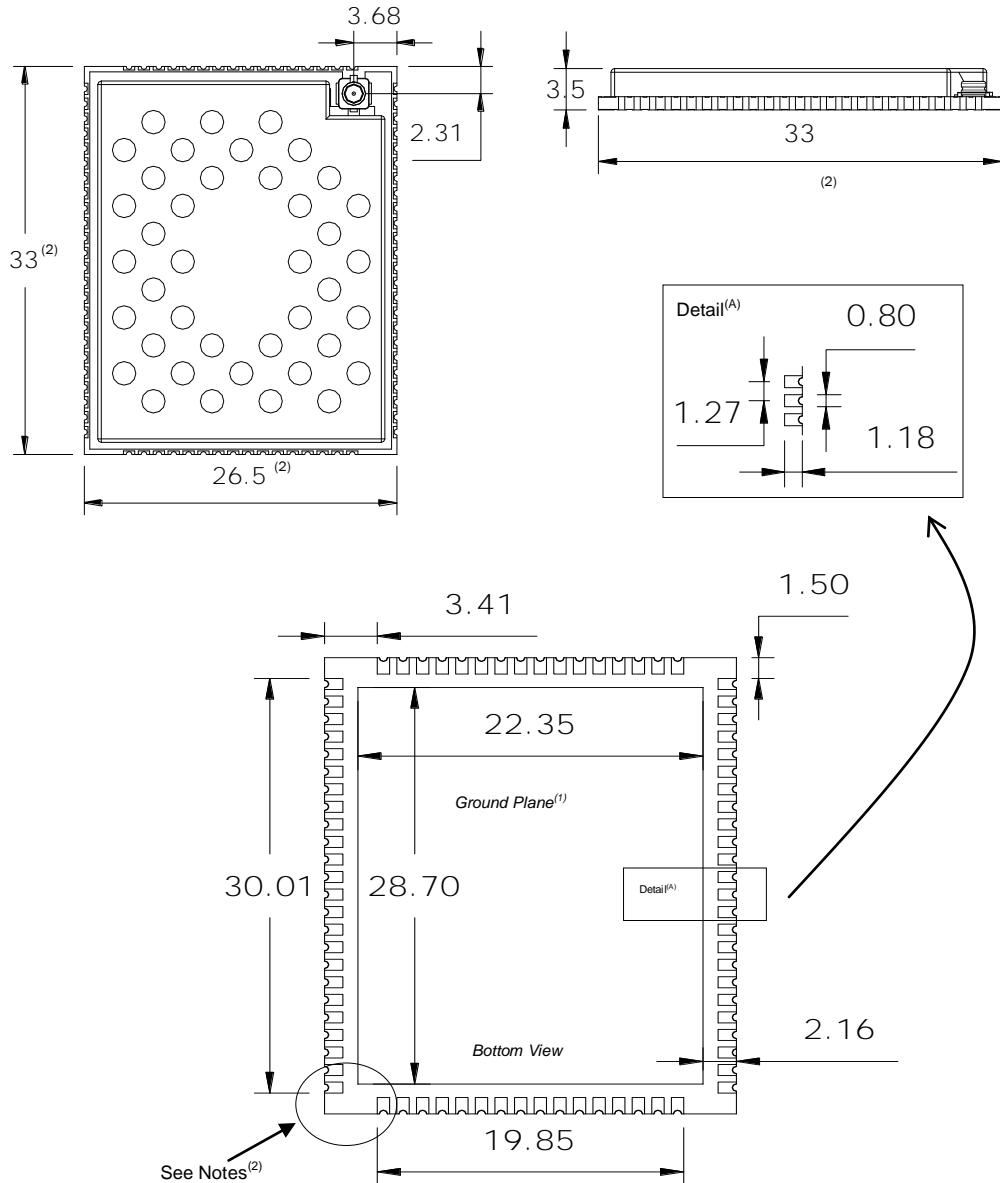

Image 2-2: SDR400 Series Bottom View

2.0 Hardware Description

2.1 Mechanical Drawings

The SDR400 OEM Modules have an extremely small form factor as seen in *Drawing 3-3 below*.



Units: millimeters

1. Ground plane must be connected to GND for required heat dissipation.
2. Due to manufacturing methods additional PCB material may be present on the corners that cannot be removed. Designs should allow for a small tolerance of this additional material, $\pm 0.25\text{mm}$

Drawing 2-1: SDR400 OEM Mechanical

2.0 Hardware Description

2.1.1 Recommended Solder Mask (Pad Landing)

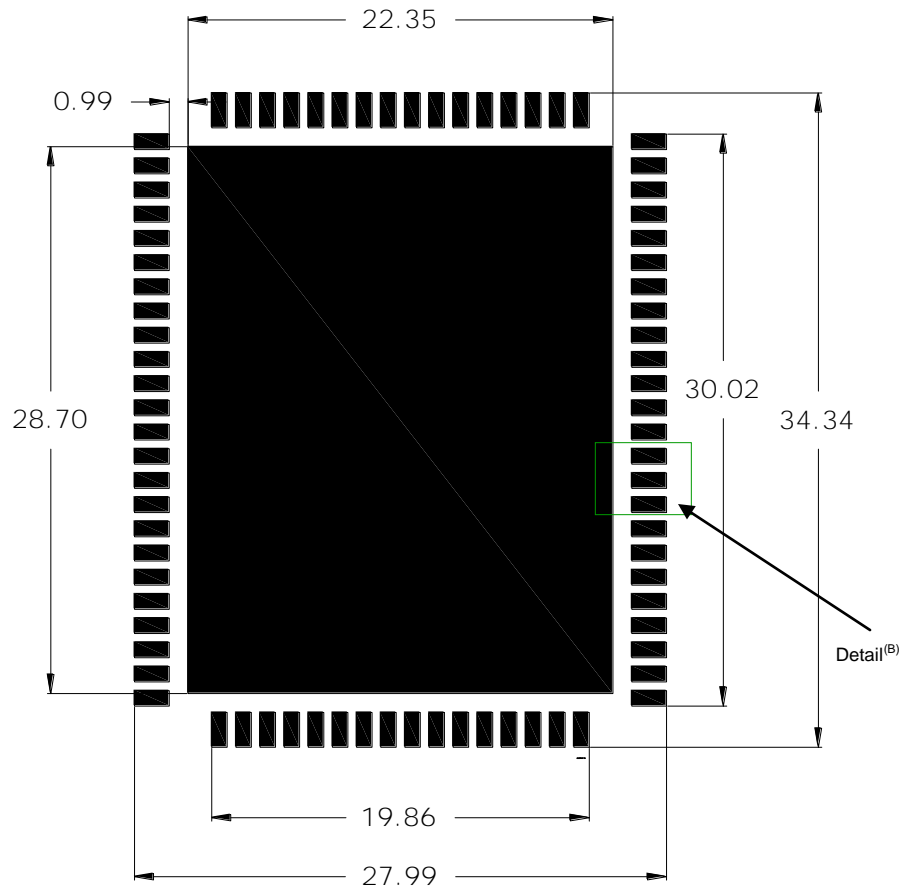

Units: millimeters

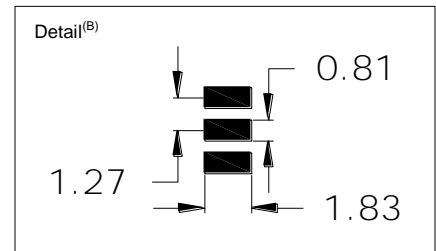

Drawing 2-2: SDR400 Recommended Solder Mask

2.0 Hardware Description

2.1.2 Recommended Solder Paste Pattern

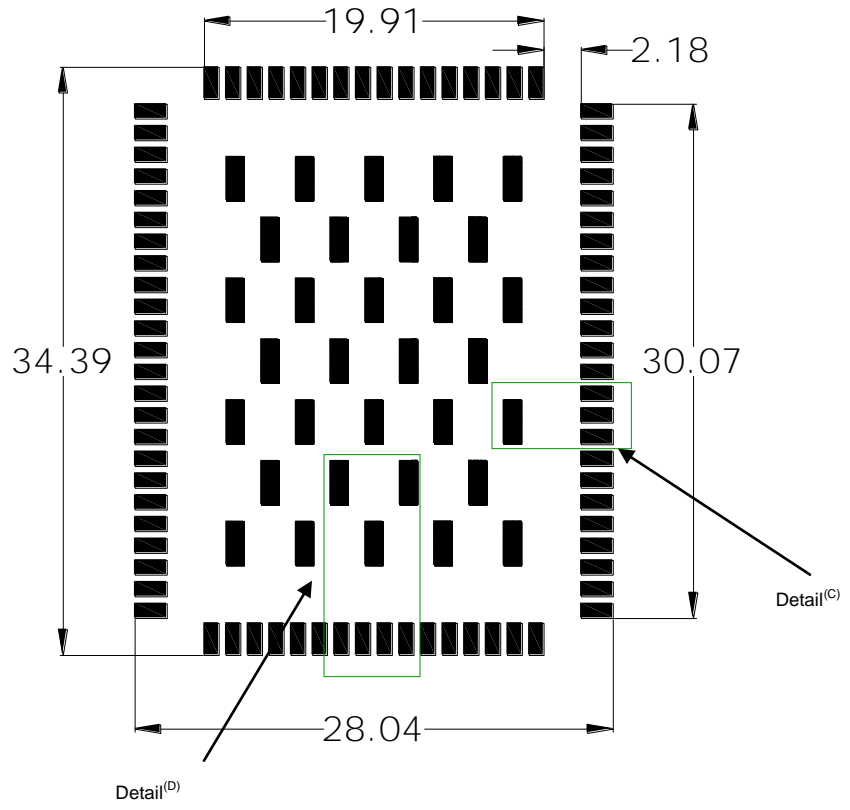

Units: millimeters

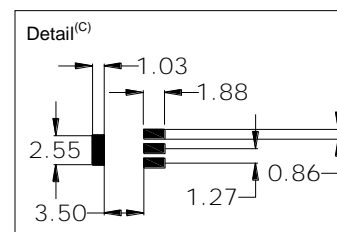
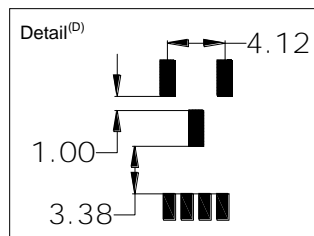

Drawing 2-3: SDR400 Recommended Solder Paste

2.0 Hardware Description

2.1.3 SMT Temperature Profile

Zone	Temperature (°C)
1	120
2	140
3	160
4	180
5	215
6	255
7	255
8	255
9	250
10	130
Chain Speed: 60cm/min	

Table 2-1: SDR400 Oven Temperature Profile

2.2 OEM Connectors

Antenna

All SDR400 OEM Modules use an UFL connector for the antenna connection.

Data

The interface to the SDR400 OEM module is a tight integration using 80 pad SMT connections.

2.0 Hardware Description

2.3 SDR400 Series Pin Descriptions

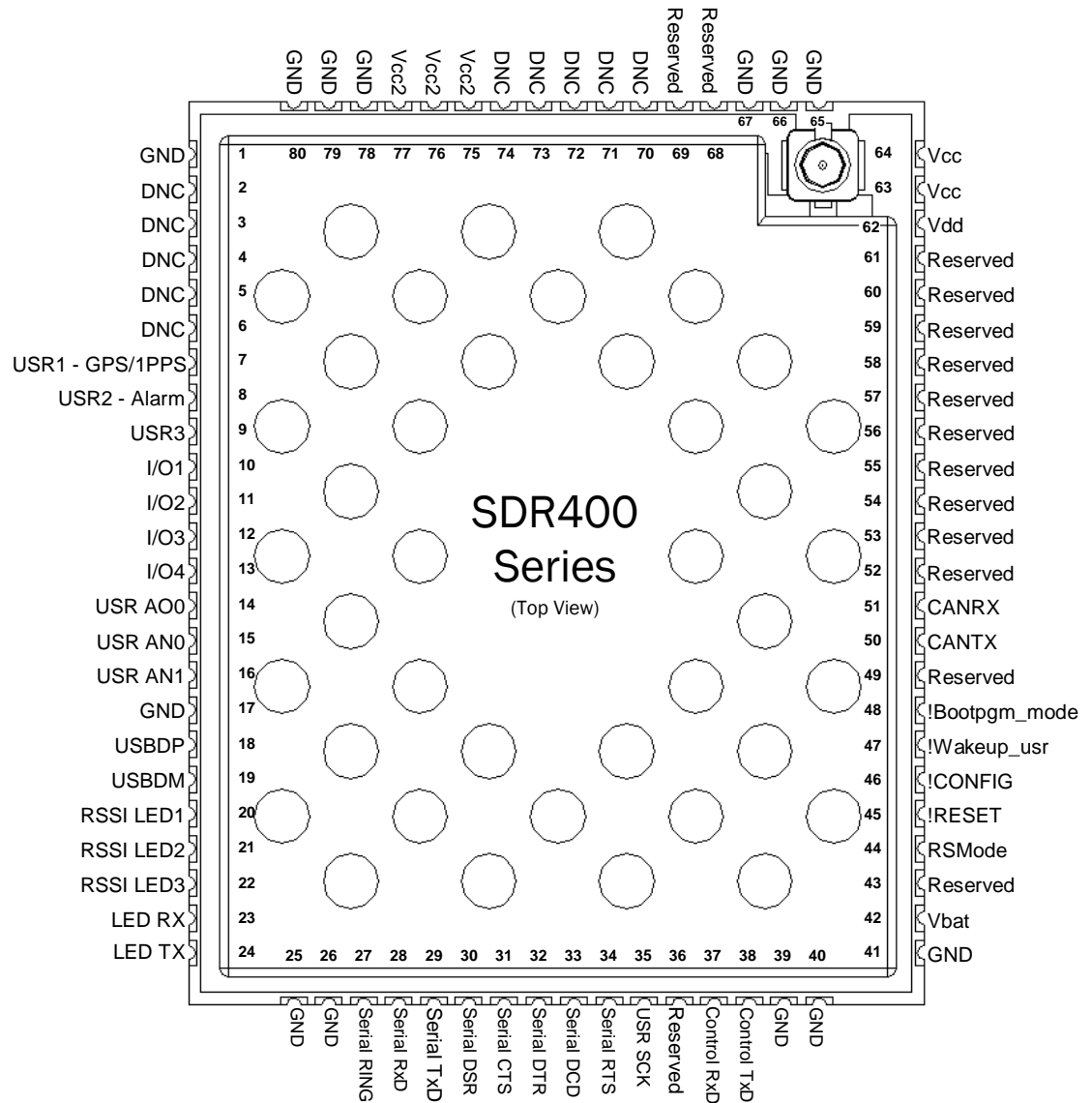

Drawing 2-4: SDR400 Series 80-pin OEM Connection Info



Inputs and outputs are 3.3V nominal (3.0V min — 3.6V max) unless otherwise specified.

The above drawing depicts a top view of the SDR400-OEM Module. The corner pads (1, 25, 41, and 65) are printed directly on the bottom of the PCB for easy identification.

A full description of the connections and function of each pin is provided on the pages that follow.

2.0 Hardware Description



Caution: During power up or reset, output pins from the SDR400 are in an unknown state. It is advised to use pull up or pull down resistors as appropriate.

Pin Name	No.	Description	Dir
GND	1,17,25-26,39-41,65-67,78-80	Ground reference for logic, radio, and I/O pins.	
DNC	2,3,4,5,6	Reserved for factory use only.	
USR1 – GPS/1PPS	7	<i>*Currently Not Supported. For Future Expansion*</i>	I
USR2 - Alarm	8	<i>*Reserved for future use.*</i>	O
USR3	9	<i>*Reserved for future use.*</i>	O
I/O1-4	10,11,12,13	Digital Input/output Pins. -0.3 to +3.6 V input, 3.3 V Output @ 3mA maximum. <i>*Future Use.*</i>	I/O
USR_ANO0	14	<i>*Currently Not Supported. For Future Expansion*</i>	O
USR_AN0 USR_AN1	15 16	Analog Inputs. 0 to 3V input, 12 bit <i>*Future Use.*</i>	I
USBDP	18	<i>*Currently Not Supported. For Future Expansion*</i>	
USBDM	19	<i>*Currently Not Supported. For Future Expansion*</i>	
LED_1 (RSSI1)	20	Receive Signal Strength Indicator 1. Active high, cannot drive LED directly. Requires current limiting resistor. 8mA maximum.	O
LED_2 (RSSI2)	21	Receive Signal Strength Indicator 2. Active high, cannot drive LED directly. Requires current limiting resistor. 8mA maximum.	O
LED_3 (RSSI3)	22	Receive Signal Strength Indicator 3. Active high, cannot drive LED directly. Requires current limiting resistor. 8mA maximum.	O
LED_RX	23	Active high output indicates receive and synchronization status. Active high, cannot drive LED directly. Requires current limiting resistor. 8mA maximum.	O
LED_TX	24	Active high output indicates module is transmitting data over the RF channel. Active high, cannot drive LED directly. Requires current limiting resistor. 8mA maximum.	O
Serial RING	27	Internally connected to GND through a 22kΩ resistor. <i>*Reserved for future use.*</i>	O
Serial RxD	28	Receive Data. Logic level input into the modem. It is recommended to wire this pin out through a zero ohm resistor to a header and jumper block for external access to the serial port for modem recovery procedures.	I
Serial TxD	29	Transmit Data. Logic level Output from the modem. It is recommended to wire this pin out through a zero ohm resistor to a header and jumper block for external access to the serial port for modem recovery procedures.	O
Serial DSR	30	Data Set Ready. Active low output. <i>The DSR line may be used to enable the transmitter of the RS485 driver chip.</i>	O
Serial CTS	31	Clear To Send. Active low output. <i>The CTS line may be used to enable the transmitter of the RS485 driver chip. (SDR400 Enclosed)</i>	O
Serial DTR	32	Data Terminal Ready. Active low input.	I
Serial DCD	33	Data Carrier Detect. Active low output.	O
Serial RTS	34	Request To Send. Active low input.	I
USR SCK	35	<i>*Currently Not Supported. For Future Expansion*</i>	I

Table 2-1: SDR400 Series Pin Description

2.0 Hardware Description



Caution: During power up or reset, output pins from the SDR400 are in an unknown state. It is advised to use pull up or pull down resistors as appropriate.

Pin Name	No.	Description	Dir
Reserved	36	<i>*Reserved for future use.*</i>	
Control RxD	37	Diagnostics receive data. Logic level input from a PC to the module. <i>Used for Diagnostics Protocol, contact Microhard Systems for documentation.</i>	I
Control TxD	38	Diagnostics transmit data. Logic level output from module to a PC. <i>Used for Diagnostics Protocol, contact Microhard Systems for documentation.</i>	O
Vbat	42	Input voltage sensing analog input line, up to 60VDC maximum. Used to measure the main supply voltage. User design must add a 10kΩ 1% 1/16W resistor in series.	I
Reserved	43	<i>*Reserved for future use.*</i>	
RSMODE	44	<i>Internally connected to GND through a 10kΩ resistor. *Reserved for future use.*</i>	O
!RESET	45	Active low input will reset the module.	I
!CONFIG	46	Active low input signal to put module into default serial interface (RS232) and default baud rate (9600/8/N/1) during power up. Pull high or leave floating.	I
!Wakeup_usr	47	<i>*Currently Not Supported. For Future Expansion*</i>	I
!Bootpgm_mode	48	<i>*Reserved for future use.*</i>	I
Reserved	49	<i>*Reserved for future use.*</i>	
CANTX	50	<i>*Currently Not Supported. For Future Expansion*</i>	
CANRX	51	<i>*Currently Not Supported. For Future Expansion*</i>	
Reserved	52-61	<i>*Reserved for future use.*</i>	
Vdd	62	Positive voltage supply voltage for the digital section of the module (3.3V).	I
Vcc	63,64	Positive voltage supply voltage for the radio module (3.3V). The Vcc lines are internally connected together.	I
Reserved	68,69	<i>*Reserved for future use.*</i>	
DNC	70-74	Reserved for factory use only.	
Vcc2	75,76,77	<i>*Reserved for future use.*</i>	I

Table 2-1: SDR400 Series Pin Description (continued)

All serial communications signals are logic level (0 and 3.3V). DO NOT connect RS-232 level (+12, -12VDC) signals to these lines without shifting the signals to logic levels.

2.0 Hardware Description

2.4 Minimum Connection Requirements

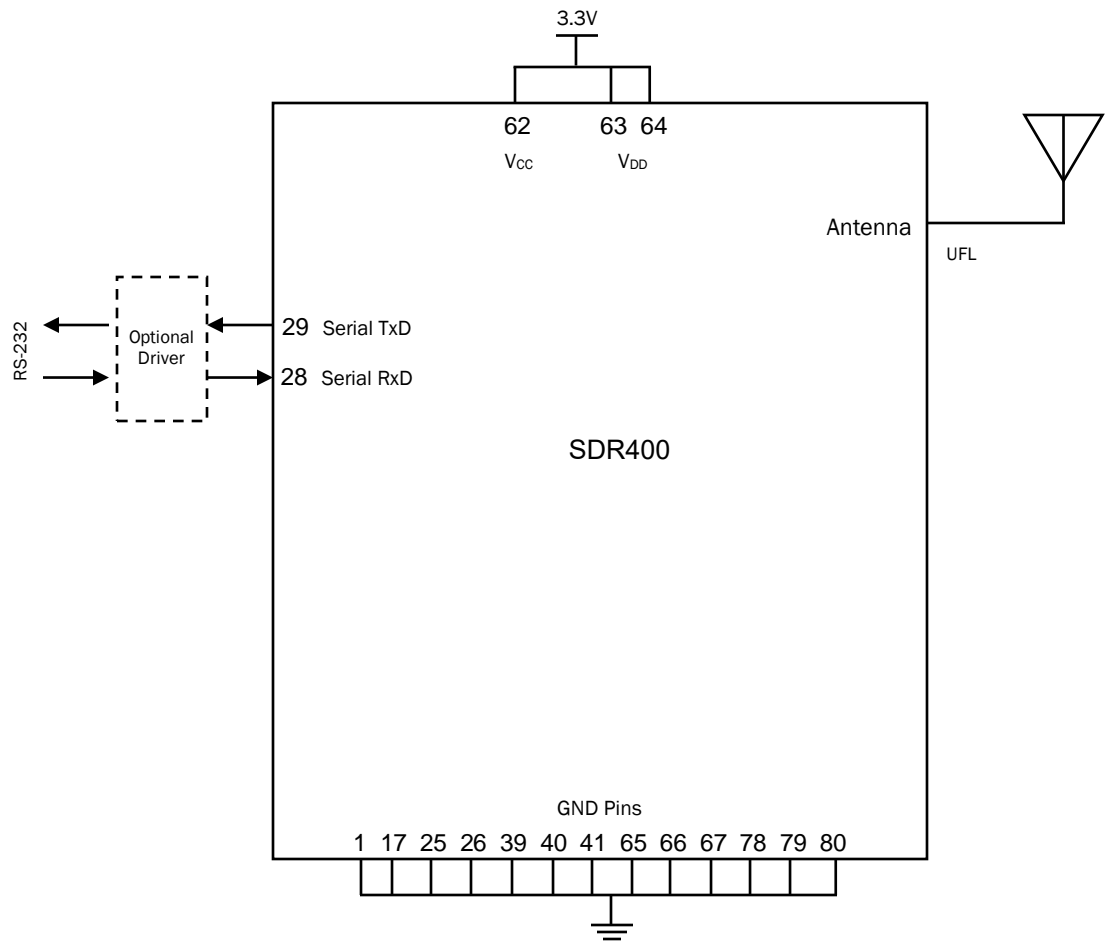

Drawing 2-5: SDR400 Minimum Connection Block Diagram

2.0 Hardware Description

2.5 Electrical Characteristics

2.5.1 Test Conditions

Unless otherwise specified, all voltages are referenced to V_{ss} (GND).

2.5.1 Minimum and Maximum Values

Unless otherwise specified the minimum and maximum values are guaranteed in the worst conditions of ambient temperature, supply voltage and frequencies.

Data based on characterization results, design simulation and/or technology characteristics are indicated in the table footnotes and are not tested in production. Based on characterization, the minimum and maximum values refer to sample tests and represent the mean value plus or minus three times the standard deviation ($\text{mean} \pm 3\sigma$).

2.5.1.2 Typical Values

Unless otherwise specified, typical data are based on $T_A = 25^\circ\text{C}$, $V_{DD} = 3.3\text{ V}$. They are given only as design guidelines and are not tested.

Typical ADC accuracy values are determined by characterization of a batch of samples from a standard diffusion lot over the full temperature range, where 95% of the devices have an error less than or equal to the value indicated ($\text{mean} \pm 2\sigma$).

2.5.1.3 Loading Capacitor

The loading conditions used for pin parameter measurement are shown in **Figure 2-1**.

2.5.1.4 Pin Input Voltage

The input voltage measurement on a pin of the SDR400 is described in **Figure 2-2**.

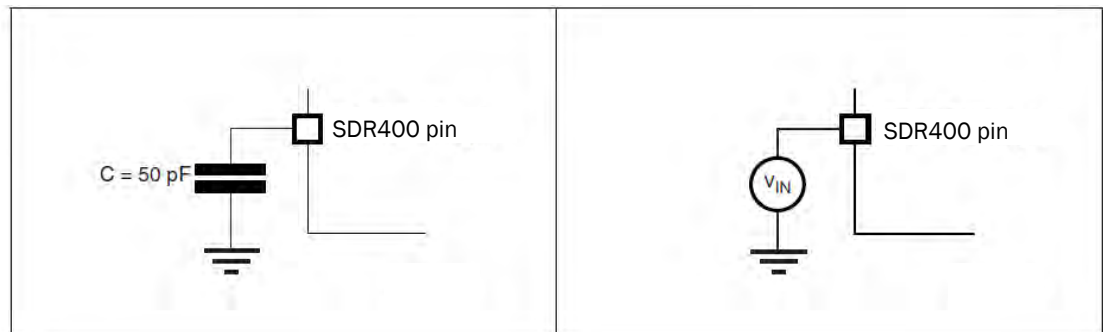

Figure 2-1 Pin Loading Conditions

Figure 2-2 Pin Input Voltage

2.0 Hardware Description

2.5.2 Absolute Maximum Ratings

Stresses above the absolute maximum ratings listed in **Table 2-2: Voltage Characteristics** and **Table 2-3: Current Characteristics** may cause permanent damage to the device. These are stress ratings only and functional operation of the device at these conditions is not implied. Exposure to maximum rating conditions for extended periods may affect device reliability.

Symbol	Ratings	Min	Max	Unit
V_{CC}/V_{DD}	External main supply voltage.	0	3.8	V
V_{IN}	Input voltage on any pin.	-0.3	$V_{DD}+0.3$	

Table 2-2 Voltage Characteristics

Symbol	Ratings	Max	Unit
I_{VDD}	Total current into SDR400 Series (source).	70	mA
I_{VSS}	Total current out of SDR400 Series (sink).	70	
I_{IO}	Output current sunk by any I/O and control pin.	20	
	Output Current sourced by any I/O and control pin.	-8	

Table 2-3 Current Characteristics

2.5.3 Operating Conditions

2.5.3.1 Operating Conditions at Power-up / Power-down

The parameters given in **Table 2-4: Operating Conditions at Power-up/ Power-down** are derived from tests performed under the ambient temperature ratings of the SDR400 Series.

Symbol	Parameter	Min	Max	Unit
t_{VDD}	V_{DD} rise time rate.	0	∞	$\mu\text{s}/\text{V}$
	V_{DD} fall time rate.	20	∞	

Table 2-4 Operating Conditions at Power-up/Power-down

2.5.3.2 Operating Conditions Voltage Characteristics

The parameters given in **Table 2-5: Operating Conditions Voltage Characteristics** are derived from tests performed under the ambient temperature ratings of the SDR400 Series.

Symbol	Ratings	Min	Max	Unit
V_{CC}	External radio supply voltage.	3.3 ⁽¹⁾	3.6	V
V_{DD}	External digital supply voltage.	3.0	3.6	

Table 2-5 Operating Conditions Voltage Characteristics

1. The modem will not be able to transit at full power if V_{CC} is less than 3.3VDC.

2.0 Hardware Description

2.5.3.3 Operating Conditions Current Characteristics

The parameters given in **Table 2-6: Operating Conditions Current Characteristics** are derived from tests performed under the ambient temperature ratings of the SDR400 Series. Test conditions measured while $V_{CC} = 3.3V$, $V_{DD} = 3.3V$, Frequency 915MHz and ambient temperature of 25°C.

Symbol	Ratings	Min	Typ	Max	Unit
$I_{VCC(TX)}$	Radio current 100% TX @ 1W		1250	1500	mA
$I_{VCC(TX)}$	Radio current 100% TX @ 500mW		375	500	
$I_{VCC(TX)}$	Radio current 100% TX @ 100mW		180	250	
$I_{VCC(RX)}$	Radio current 100% RX @ 1W		75	100	
$I_{VCC(RX-RUN)}$	Radio RX running		40	75	
$I_{VCC(IDLE)}$	Radio Idle current		2.5	3.5	
$I_{VDD(RUN)}$	Digital current		45	50	
$I_{VDD(IDLE)}$	Digital idle current		5		

Table 2-6 Operating Conditions Current Characteristics

2.5.3.4 I/O Port Characteristics

General Input / Output Characteristics

The parameters given in **Table 2-7: I/O Static Characteristics** are derived from tests performed under the ambient temperature ratings of the SDR400 Series. All I/Os are CMOS and TTL compliant. I/O's refer to all input and outputs of the SDR400 Series.

Symbol	Parameter	Conditions	Min	Typ	Max	Unit
V_{IL}	Input low level voltage	TTL ports	-0.5		0.8	V
V_{IH}	Input high level voltage		2		$V_{DD}+0.5$	
V_{IL}	Input low level voltage	CMOS ports	-0.5		$0.35 V_{DD}$	V
V_{IH}	Input high level voltage		$0.65 V_{DD}$		$V_{DD}+0.5$	
V_{hys}	IO Schmitt trigger voltage hysteresis ⁽¹⁾		200			mV
I_{Ikg}	Input leakage current	$V_{SS} \leq V_{IN} \leq V_{DD}$			± 1	μA
R_{PU}	Weak pull-up equivalent resistor ⁽²⁾	$V_{IN} = V_{SS}$	30	40	50	k Ω
R_{PD}	Weak pull-down equivalent resistor ⁽²⁾	$V_{IN} = V_{DD}$	30	40	50	
C_{IO}	I/O pin capacitance			8		pF

1. Hysteresis voltage between Schmitt trigger switching levels. Based on characterization, not tested in production.
2. Pull-up and pull-down resistors can be used on input/output pins.

Table 2-7 I/O Static Characteristics

2.0 Hardware Description

Output Driving Current

The GPIOs (general purpose input/outputs) can sink or source up to +/-8 mA, and sink +20 mA (with a relaxed V_{OL}).

In the user application, the number of I/O pins which can drive current must be limited to respect the absolute maximum rating specified in **Section 2.1.4.2**:

- The sum of the currents sourced by all the I/Os on VDD cannot exceed the absolute maximum rating I_{VDD} (see **Table 2-3**).
- The sum of the currents sunk by all the I/Os on VSS cannot exceed the absolute maximum rating I_{VSS} (see **Table 2-3**).

Output Voltage Levels

Unless otherwise specified, the parameters given in **Table 2-8** are derived from tests performed under ambient temperature and V_{DD} supply voltage ratings of the SDR400 Series. All I/Os are CMOS and TTL compliant.

Symbol	Parameter	Conditions	Min	Max	Unit
$V_{OL}^{(1)}$	Output low level voltage for an I/O pin when 8 pins are sunk at same time	TTL port $I_{IO} = +8mA$		0.4	V
$V_{OH}^{(2)}$	Output high level voltage for an I/O pin when 8 pins are sourced at same time		$V_{DD}-0.4$		
$V_{OL}^{(1)}$	Output low level voltage for an I/O pin when 8 pins are sunk at same time	CMOS port $I_{IO} = +8mA$		0.4	V
$V_{OH}^{(2)}$	Output high level voltage for an I/O pin when 8 pins are sourced at same time		2.4		
$V_{OL}^{(1)(3)}$	Output low level voltage for an I/O pin when 8 pins are sunk at same time	$I_{IO} = +20mA$		1.3	V
$V_{OH}^{(2)(3)}$	Output high level voltage for an I/O pin when 8 pins are sourced at same time		$V_{DD}-1.3$		

1. The I_{IO} current sunk by the device must always respect the absolute maximum rating specified in **Table 2-3** and the sum of I/O ports and control pins must not exceed I_{VSS} .
2. The I_{IO} current sourced by the device must always respect the absolute maximum rating specified in **Table 2-3** and the sum of I_{IO} (I/O ports and control pins) must not exceed I_{VDD} .
3. Based on characterization data, not tested in production.

Table 2-8 Output Voltage Characteristics

Input / Output AC Characteristics

The values of input/output AC characteristics are given in Table 2-9.

Symbol	Parameter	Conditions	Min	Max	Unit
$t_{r(I/O)out}$	Output high to low fall time	CL = 50 pF		125	ns
$t_{r(I/O)out}$	Output low to high level rise time			125	
t_{EXTIpw}	Pulse width of external signals used as interrupts.		1		ms

Table 2-9 Input / Output AC Characteristics

2.0 Hardware Description

NRST Pin Characteristics

The NRST pin input driver uses CMOS technology. It is connected to a permanent pull-up resistor, RPU (see **Table 2-7**).

Symbol	Parameter	Conditions	Min	Typ	Max	Unit
$V_{IL(NRST)}$	NRST Input low level voltage		-0.5		0.7	V
$V_{IH(NRST)}$	NRST Input high level voltage		2		$V_{DD}+0.5$	
$V_{hys(NRST)}$	NRST Schmitt trigger voltage hysteresis			200		mV
R_{PU}	Weak pull-up equivalent resistor	$V_{IN}=V_{SS}$	30	40	50	k Ω
V_{NF}	NRST Input pulse		300			ns

Table 2-10 NRST Pin Characteristics

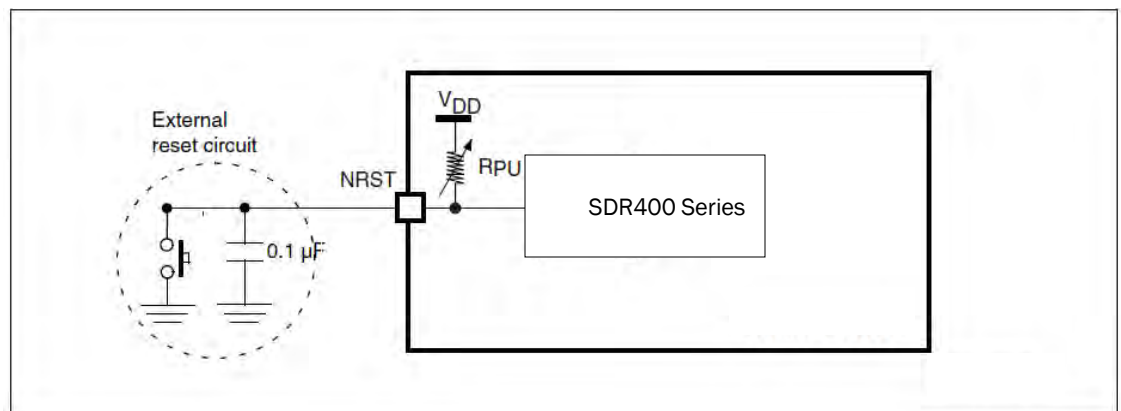

Figure 2-3 Recommended NRST Pin Protection

2.5.3.5 12-bit ADC Characteristics

The parameters given in **Table 2-11: ADC Characteristics** are derived from tests performed under the ambient temperature and supply voltage ratings of the SDR400 Series.

Symbol	Parameter	Min	Max	Unit
V_{AIN}	Conversion voltage range	0	3.0	V
R_{AIN}	External input impedance	0	1.2	k Ω

Table 2-11 12-bit ADC Characteristics

Symbol	Parameter	Test Conditions	Typ	Max	Unit
ET	Total unadjusted error	$T_A = 25^{\circ}\text{C}$	1.3	2	LSB
EO	Offset error		1	1.5	
EG	Gain error		0.5	1.5	
ED	Differential linearity error		0.7	1	
EL	Integral linearity error		0.8	1.5	

Table 2-12 ADC Accuracy

2.0 Hardware Description

ADC Accuracy Characteristics

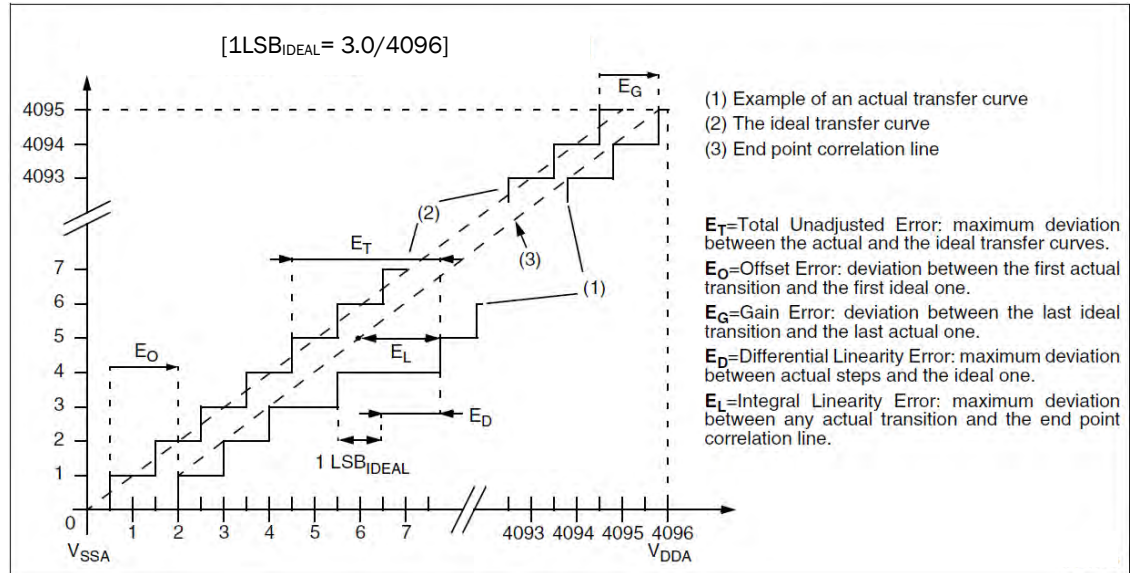

Figure 2-4 ADC Accuracy Characteristics

2.0 Hardware Description

2.6 SDR400 to Nano n920 Pin-Outs

The following table shows a pin-out comparison between the SDR400 and the n920. This table may be useful for customers who current have the n920 who wish to migrate to the SDR400 platform.



For detailed pin descriptions refer to Section 2.3 Pin Description.

Pin Name	SDR400 Pin N	n920 Pin No.	Description
USR1	7	35	<i>*Currently Not Supported. For Future Expansion*</i>
USR2	8	37	<i>*Reserved for future use.*</i>
USR3	9	39	<i>*Reserved for future use.*</i>
USR_AN0	15	9	Analog Input 0. <i>*Future Use.*</i>
USBDP	18	25	<i>*Currently Not Supported. For Future Expansion*</i>
USBDM	19	21	<i>*Currently Not Supported. For Future Expansion*</i>
LED_1 (RSSI1)	20	30	Receive Signal Strength Indicator 1.
LED_2 (RSSI2)	21	28	Receive Signal Strength Indicator 2.
LED_3 (RSSI3)	22	26	Receive Signal Strength Indicator 3.
LED_RX	23	22	Active high output indicates receive and synchronization status.
LED_TX	24	24	Active high output indicates module is transmitting RF data.
Serial RING	27	38	<i>*Reserved for future use.*</i>
Serial RxD	28	42	Receive Data. Logic level input into the modem.
Serial TxD	29	44	Transmit Data. Logic level Output from the modem.
Serial DSR	30	36	Data Set Ready. Active low output.
Serial CTS	31	32	Clear To Send. Active low output.
Serial DTR	32	40	Data Terminal Ready. Active low input.
Serial DCD	33	46	Data Carrier Detect. Active low output.
Serial RTS	34	34	Request To Send. Active low input.
USR SCK	35	50	<i>*Currently Not Supported. For Future Expansion*</i>
Control RxD	37	20	Diagnostics receive data.
Control TxD	38	18	Diagnostics transmit data.
Vbat	42	17	Battery Voltage sensing analog input line.
RSMODE	44	19	<i>*Reserved for future use.*</i>
!RESET	45	15	Active low input will reset the module.
!CONFIG	46	13	Active low input signal to put module into default serial mode.
!WakeUp_usr	47	11	<i>*Currently Not Supported. For Future Expansion*</i>
!Bootpgm_mode	48	7	<i>*Reserved for future use.*</i>
CANTX	50	12	<i>*Currently Not Supported. For Future Expansion*</i>
CANRX	51	10	<i>*Currently Not Supported. For Future Expansion*</i>
Vdd	62	51,53,55,57,59	Positive voltage supply voltage for the digital section of the module (3.3V).
Vcc	63,64		Positive voltage supply voltage for the radio module (3.3V).
Vcc2	75,76,77	N/A	<i>*Reserved for future use.*</i>

Table 2-13: SDR400 to Nano n920 Pin Description

2.0 Hardware Description

2.7 SDR400 Enclosed

The SDR400 Enclosed provides a standalone SDR400 with standard interfaces for Data, Power and Antennas. The SDR400 Enclosed is ideal for base stations or applications where complicated integration of the OEM module is not required, but a modem with a small footprint is still required. The SDR400 Enclosed can also be used to quickly evaluate the features and performance of the SDR400 modems.

The SDR400 Enclosed provides quick access to several of the interfaces of the SDR400, such as:

- Input Power (9-30VDC)
- Power LED (Blue)
- RS232/RS485 Data Interface
- RSSI LED Indicators (Green)
- TX/RX LED Indicators (Red/Green)
- CONFIG Button
- Antenna
- USB Port (Internal Serial to USB (Diagnostics Port))
- I/O pins (Future Development)



Image 2-4: SDR400 Enclosed

2.0 Hardware Description

2.7.1 SDR400 Enclosed Dimensional Drawings

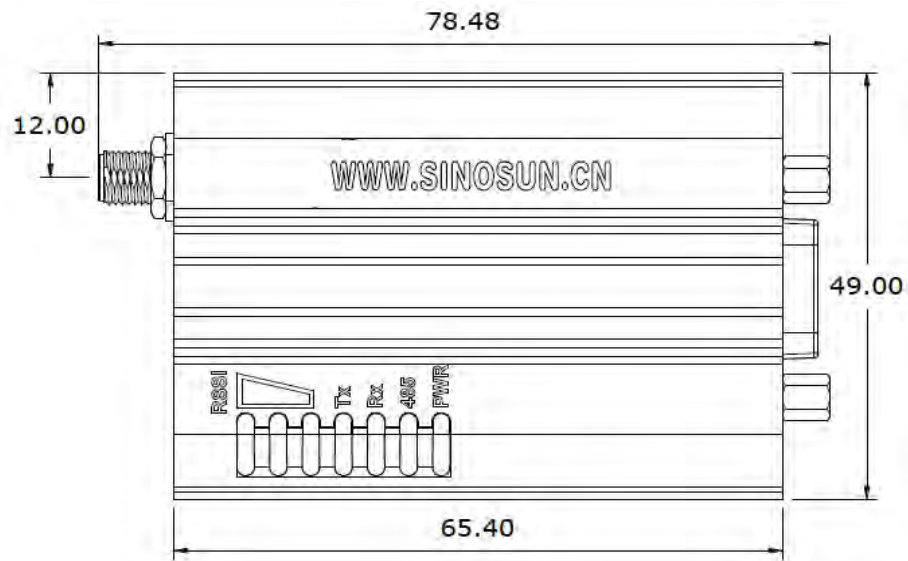

Drawing 2-6: SDR400 Top View

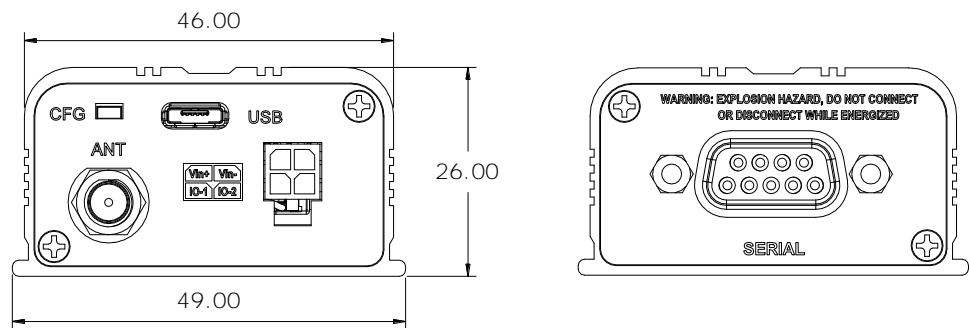

Drawing 2-7: SDR400 Enclosed End Views

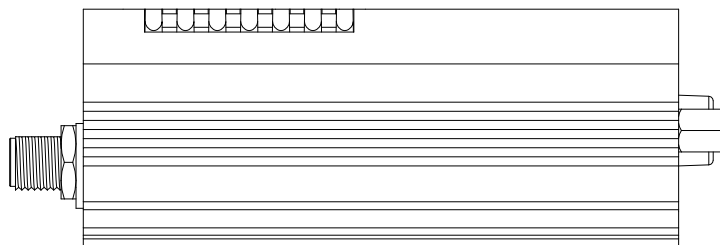

Drawing 2-8: SDR400 Enclosed Side View

Notes: The dimension unit is mm.

2.0 Hardware Description

2.7.2 SDR400 Enclosed Mounting Bracket (Order Option)

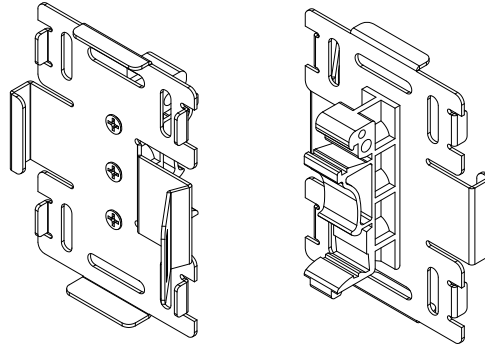

Drawing 2-6: SDR400 –ENC Mounting Bracket Front/Rear (Shown optional TS35 DIN Rail Mount)

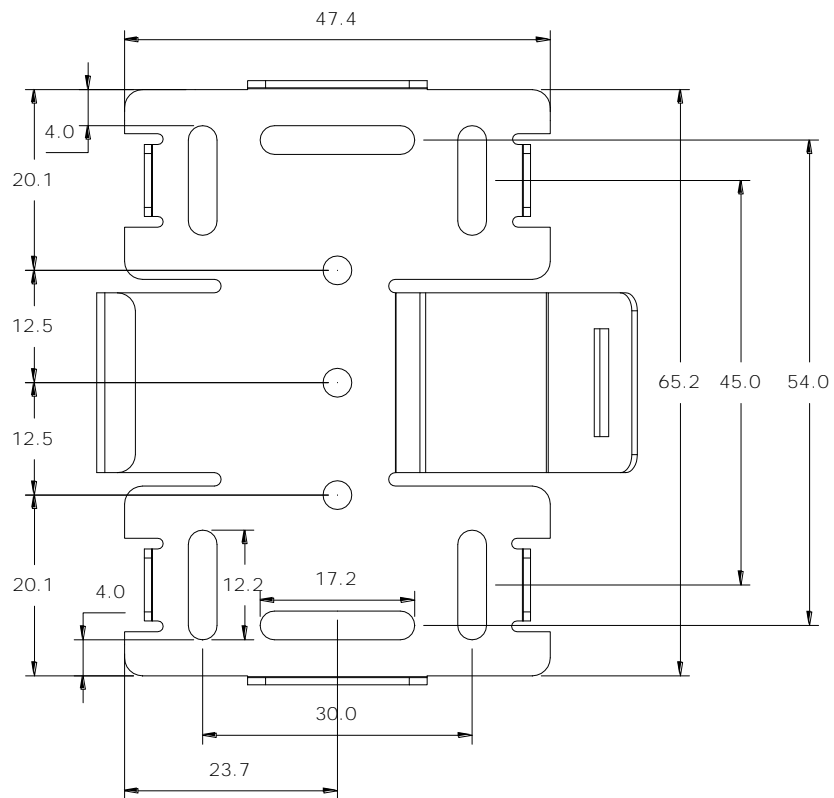

Notes: The dimension unit is mm.

2.0 Hardware Description

2.7.3 SDR400 Enclosed Connectors & LED Indicators

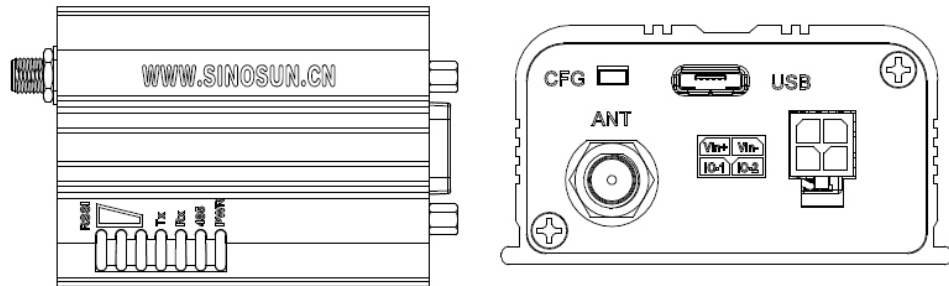

Drawing 2-9: Connectors & LED's (Top & End)

PWR (Blue)

This LED will illuminate when the SDR400 Enclosed is connected to a power source (9-30 VDC)

485 (Blue)

This LED will illuminate when the SDR400 Enclosed Data port is configured as a RS485 port. (Register S142 Serial Channel Mode set to RS485 and Handshaking set to &K1)

TX LED (Red)

When illuminated, this LED indicates that the modem is transmitting data over the air.

RX LED (Green)

This LED indicates that the modem is synchronized and has received valid packets.

Receive Signal Strength Indicator (RSSI) (3x Green)

As the received signal strength increases, starting with the furthest left, the number of active RSSI LEDs increases. Signal strength is calculated based on the last four valid received packets with correct CRC. The value of RSSI is reported in S123.

MODE	Unit Type	LED STATUS		
		RX/SYNC	TX	RSSI 1,2,3
COMMAND	All	OFF	OFF	OFF
DATA	Master Repeater	ON while receiving valid data	ON while Transmitting data	1-3 ON in proportion to signal strength received from remotes.
DATA - during sync. acquisition	Remote	OFF	OFF	Cycling with 300ms ON time
DATA - when synchronized	Remote	ON while synced	ON when transmitting	1-3 ON in proportion to signal strength received from Master/ Repeater

Table 2-14: FH Modems LED Operation

2.0 Hardware Description

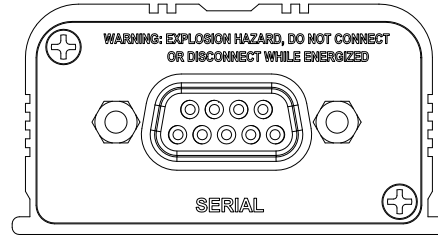

Drawing 2-10: Connectors & LED's (Front & Back)

CFG Button

Holding this button while powering-up the modem will boot the unit into COMMAND mode: the default serial interface will be active and temporarily set to operate at its default serial settings of RS232 and 9600/8/N/1.

USB

Micro-AB USB Port. Internal USB to Serial Converter. Provides access to the Serial Diagnostics Port.

The **SERIAL** (RS232/485 Port (DCE)) on the Enclosed model is for:

- RS232/485 Serial data when in **DATA MODE**, or
- for configuring the modem when in **COMMAND MODE**.

Pin No.	RS232	RS485 Full-Dup	RS485 Half-Dup
1	DCD		
2	RXD	RX+	
3	TXD	TX-	Data-
4	DTR		
5	Ground		
6	DSR		
7	RTS	TX+	Data+
8	CTS	RX-	
9	N/C		

Table 2-15: Data DB9 Pin Assignments



Caution: Using a power supply that does not provide proper voltage may damage the modem.

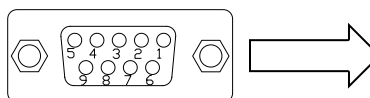

Vin+/Vin- is used to power the unit. The input Voltage range is 9-30 Vdc.

IO-1 / IO-2

Programmable I/O. Not currently supported in firmware. Future Development.

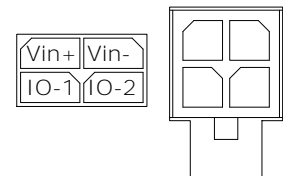

ANT

RP-SMA Female Bulkhead Antenna connector.

3.0 400 MHz Licensed Band Configuration

To begin configuration, the SDR400 must be mounted into either a Microhard supplied development board (with factory attached interface card), or be mounted into a customer designed platform. The SDR400 is configured using AT commands through the **Data** port, or using special diagnostic commands through the **Diagnostic** Port. Refer to [Section 2: Hardware Description](#) for information related to inter-facing to, or powering the module.

To issue AT commands through the **Data** port, the SDR400 must first be set into **Command Mode** as de-scribed below.

3.1 Configuration/Unit Modes

3.1.1 Command Mode

- the SDR400 module is offline (data is not passing through the unit via it's local data lines or RF communications)
- if installed in a Dev Board, the only LED illuminated will be the blue power LED.
- the SDR400's configuration options (registers) may be viewed and modified using AT commands.

Two methods are typically used to place the SDR400 Series into Command Mode.

1. Force to Command Mode

- Power down off the Development Board assembly.
- Connect a 9-pin straight-through serial cable from the PC serial port to the rear RS-232 port (DATA) of the modem.
- Launch a terminal communications program (e.g. HyperTerminal) and configure for 9600bps, 8 data bits, No parity, 1 stop bit (8N1), no flow control
- press and hold the CONFIG button
- continue to press the CONFIG button and apply power to the modem
- release the CONFIG button
- On power up the terminal session window should show "NO CARRIER OK" as seen below:

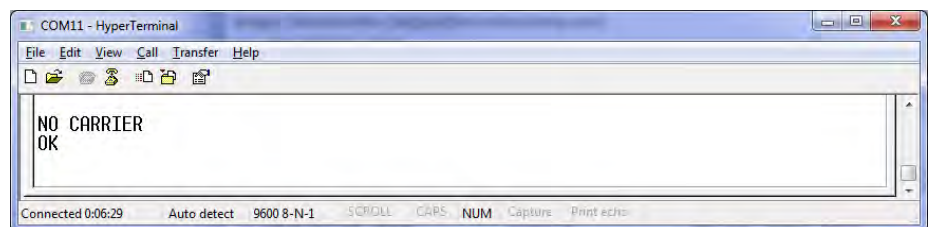

Image 3-1: Command Mode

- the SDR400 is now in command mode, and AT commands can be used to configure or query the settings. AT&V will display the current configuration, and the registers can be queried using the AT&SXXX=? Command where XXX = the register number. Help is available using the AT&SXXX /? Command.
- Any and all changes must be written to NVRAM using the AT&W command.

3.0 400 MHz Licensed Band Configuration

2. Escape from Data Mode

- With the SDR400 powered up and 'online', connect a 9-pin straight-through serial cable from the PC serial port to the RS-232 DATA port on the dev board.
- Launch a terminal program (e.g. HyperTerminal) and configure for the SDR400's established serial baud rate parameters (PC & modem must match).
- Pause 1 second, type '+++', pause 1 second: the monitor should show the module response of 'NO CARRIER OK'

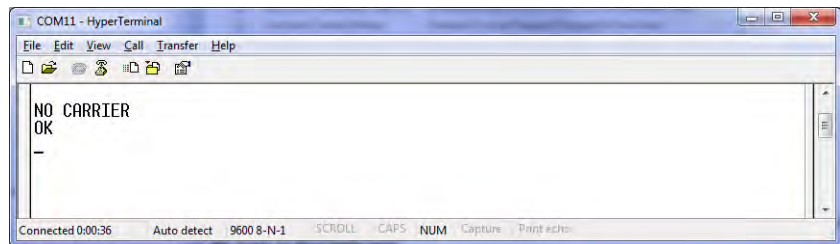

Image 3-2: Command Mode

- The SDR400 is now in command mode, and AT commands can be used to configure or query the settings.
- Entering the AT&V command as shown will show the current configuration as seen below: (The data displayed varies based on network and unit type.)

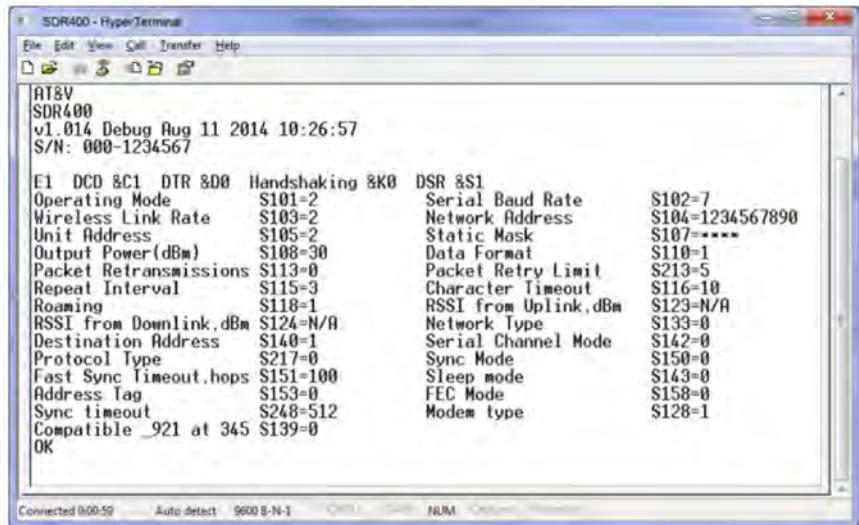

Image 3-3: Command Mode - AT&V Display

3.1.2 Data Mode

Data Mode is the normal operational state of all deployed SDR400 modules. In this mode the module is prepared to exchange data as per its configuration settings. Available LED indications can provide an indication of the data exchange (TX and RX LEDs).

To enter DATA mode from COMMAND mode, enter the command: **ATA [Enter]**

3.0 400 MHz Licensed Band Configuration

3.1.3 Modem Type

The SDR400 is a Multi-Frequency Modem that is capable of operating in one of three (3) different modem types. The three different modem types of the SDR400 are (1) 400 MHz Narrowband Licensed Band Mo-dem, (2) 900 MHz FHSS modem operating in the 900 MHz ISM band and (3) as a 400 MHz Frequency Hopping Modem. It is important to set the correct modem type before commencing with any additional configuration parameters.

This section describes the configuration of a modem that has been set to operate as a 400 MHz Licensed Band Narrowband Modem. ***It should also be noted that the frequency channels must be set by a approved Dealer prior to modem operation/configuration. To comply with regulations this is documented and maintained in a separate document known as the 'Dealer Notes'. Contact your dealer or Microhard Systems for a copy of this document.***



Registers can be changed by entering the AT command as seen below:

Example:
ATS128=0 <enter>

Any registers that are changed must be written to flash using the **AT&W** command

The modem type can be selected using the register S128 (Modem Type) as follows:

Modem Type S128	= 0 - 400 MHz Narrow Band (NB) Modem
	= 1 - 900 MHz Frequency Hopping (FH) Modem
	= 2 - 400 MHz Frequency Hopping (FH) Modem*

* 400 MHz FHSS is an order option (-C2S or -C1S) and must be specified at time of order and enabled at the factory.

The following image shows the current options for the modem type as described above.

```
ATS128 /?
Modem type. 0 - 400MHz Narrow Band (NB) Modem, 1 - 900MHz Frequency Hopping (FH)
Modem, 2 - 400MHz Frequency Hopping (FH) Modem
OK
```

Image 3-4: Modem Type S128

The configuration of the SDR400 relies on setting several parameters (S Registers). To simply configuration it is strongly recommended that the Factory Default Commands (ATFn) be used for initial configuration. The factory default commands are described in the following sections. When using the factory commands, all registers, including the Modem Type (S128) described above, will automatically be changed to a factory default recommended values that allow basic communication between devices.

3.1.3.1 Call Sign ID

Firmware v1.030 implements the Call Sign ID (required by FCC), for all protocols of narrowband modes. The modem will not receive any wireless data during transmitting Call Sign ID. Local serial data received from user during Call Sign ID transmission will be accumulated and will be sent after the Call Sign ID transmission. The duration of Call Sign is determined by register S228. If the register S228 is empty (default), modem shows word "Empty". The registers S228 (ID) and S233 (Interval) were added.

- the 1 minute time-out is expired after going on-line from AT-menu, Modem transmits Call Sign ID when:
- the S233 time-out in minutes is expired if modem transmits data during this time interval.

Modem will not send Call Sign ID if the Call Sign ID string in S228 is empty or there is no Tx activity after power up.

3.0 400 MHz Licensed Band Configuration

3.1.4 Factory Default Settings (ATFn)

The SDR400 is compatible with and can communicate directly with several brands of GPS transceivers, such as Trintalk, Pacific Crest and Satel. Due to the large number of configuration parameters available, Microhard has developed a series of Factory Default Commands that can be used to simplify the configuration process.

The user simply selects the model that is to be configured and enters a single command (In the tables in the following sections) that takes care of all basic communication (Wireless) related settings. The following screen shot lists the currently available commands available on the SDR400. The top section (which has been deleted), refers to Frequency Hopping modems and are described in their respective sections. The lower portion, shown below, lists the currently available AT&F commands for the Narrowband/Licensed modes. To display the list supported by your device, the 'AT&F /?' command can be used.

Narrow Band (NB) modems	
&F51	- NB Transparent Protocol, Rate=9.6kbps, BW=25kHz, 2FSK
&F52	- NB Transparent Protocol w Rep., Rate=9.6kbps, BW=25kHz, 2FSK
&F53	- NB Pac.Crest Trans.Protocol, Rate=9.6kbps, BW=25kHz, FEC On, 2FSK
&F54	- NB Trintalk 450s Protocol no Rep., Rate=9.6kbps, BW=25kHz, 2FSK
&F55	- NB Trintalk 450s Protocol Rep.1, Rate=9.6kbps, BW=25kHz, 2FSK
&F56	- NB Trintalk 450s Protocol Rep.2, Rate=9.6kbps, BW=25kHz, 2FSK
&F57	- NB Trintalk 450s Protocol Base w Rep., Rate=9.6kbps, BW=25kHz, 2FSK
&F58	- NB Satel 3AS Protocol, Bit Rate=9.6kbps, BW=12.5kHz, 4FSK
&F59	- NB Satel 3AS Protocol, Bit Rate=19.2kbps, BW=25kHz, 4FSK
&F60	- NB Satel 3AS Protocol, BitRate=9.6kbps, BW=12.5kHz, FEC Off, 4FSK, Type 1
&F61	- NB Satel 3AS Protocol, BitRate=19.2kbps, BW=25kHz, FEC Off, 4FSK, Type 1
&F62	- NB Pac.Crest Trans.Protocol, Bit Rate=4.8kbps, BW=12.5kHz, FEC On, 2FSK
&F63	- NB Trintalk Protocol, Bit Rate=4.8kbps, BW=12.5kHz, 2FSK
&F64	- NB Pac.Crest 4FSK Protocol, BitRate=9.6kbps, BW=12.5kHz, FEC On, 4FSK
&F65	- NB Pac.Crest 4FSK Protocol, BitRate=19.2kbps, BW=25kHz, FEC On, 4FSK
&F66	- NB Pac.Crest FST Protocol, BitRate=9.6kbps, BW=12.5kHz, FEC On, 4FSK
&F67	- NB Pac.Crest FST Protocol, BitRate=19.2kbps, BW=25kHz, FEC On, 4FSK
&F68	- NB Pac.Crest FST Protocol, BitRate=9.6kbps, BW=12.5kHz, FEC On, 4FSK, Type2
&F69	- NB Pac.Crest FST Protocol, BitRate=19.2kbps, BW=25kHz, FEC On, 4FSK, Type2

Image 3-5: Factory Defaults (AT&F /?)

The factory default commands save the user from having to remember dozens of commands and/or the task of trying to figure out which registers are important and which are not. The commands also provide a known starting point in which to base any configuration, as it overwrites all registers to the factory recommended default values. For this reason it is important, regardless of the configuration, to always start with the factory commands. After which a few other commands may be required to configure the modem to meet the needs of the user. A few of these registers that may need to be configured to meet the specific application of the user are:

S108	-	Output Power (Should be set to minimum required value)
S102	-	Serial Baud Rate (Should be set to match connected serial device)
S110	-	Data Format (Should be set to match connected serial device)
S131	-	Main Tx Frequency (Should be set according to frequency table*)
S132	-	Main Rx Frequency (Should be set according to frequency table*)
S191	-	Repeater Tx Frequency (If using Repeaters in your system*)
S192	-	Repeater Rx Frequency (If using Repeaters in your system*)

* Reminder: The frequency Table/Channels must be populated prior to any configuration. It is to be populated at the factory or by a authorized dealer. To comply with regulations this is documented and maintained in a separate document known as the 'Dealer Notes'. Contact your dealer or Microhard Systems for a copy of this document.

3.0 400 MHz Licensed Band Configuration

3.2 Microhard Low Latency Transparent Mode

Transparent mode is designed to transmit and receive data packets as soon as there is data. The biggest advantage of this mode is low latency of data delivery. In the low latency transparent mode a modem will start to transmit a packet as soon as it detects received serial data, without waiting for time-out to be expired.

For transparent mode protocol, there is no concept of slave or master. Instead, every unit has the same basic settings in a transparent mode network. A modem in transparent mode can work as transmitter or receiver. The packets from the transmitter will be received by every receiver in the network.

A modem in transparent mode outputs data to serial user interface when it receives data from others. For low latency transparent mode, data will be output byte by byte immediately when a packet is being received. The packet consists of blocks, each of which is protected by CRC. So the modem will stop outputting further data as long as it detects any CRC error by the end of each block.

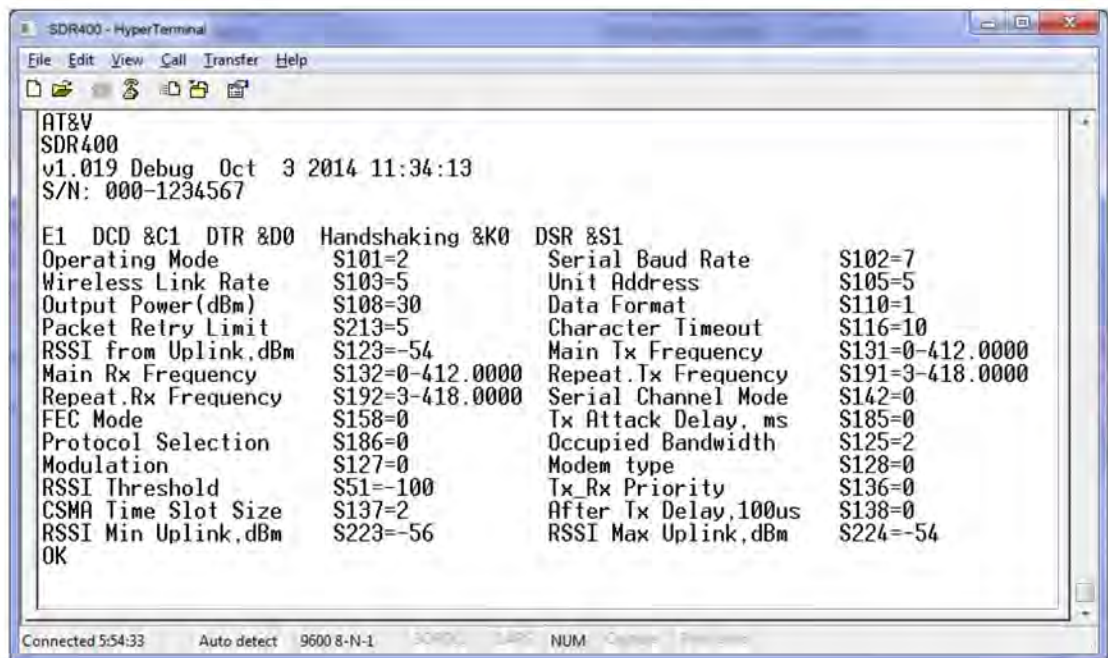

```
SDR400 - HyperTerminal
File Edit View Call Transfer Help
SDR400
v1.019 Debug Oct 3 2014 11:34:13
S/N: 000-1234567

E1 DCD &C1 DTR &D0 Handshaking &K0 DSR &S1
Operating Mode S101=2 Serial Baud Rate S102=7
Wireless Link Rate S103=5 Unit Address S105=5
Output Power(dBm) S108=30 Data Format S110=1
Packet Retry Limit S213=5 Character Timeout S116=10
RSSI from Uplink,dBm S123=-54 Main Tx Frequency S131=0-412.0000
Main Rx Frequency S132=0-412.0000 Repeat Tx Frequency S191=0-418.0000
Repeat Rx Frequency S192=0-418.0000 Serial Channel Mode S142=0
FEC Mode S158=0 Tx Attack Delay, ms S185=0
Protocol Selection S186=0 Occupied Bandwidth S125=2
Modulation S127=0 Modem type S128=0
RSSI Threshold S51=-100 Tx Rx Priority S136=0
CSMA Time Slot Size S137=2 After Tx Delay,100us S138=0
RSSI Min Uplink,dBm S223=-56 RSSI Max Uplink,dBm S224=-54
OK

Connected 5:54:33 Auto detect 9600 8-N-1 SDR400 SDR400 NUM
```

Image 5-1: Transparent Mode AT&V Menu

3.0 400 MHz Licensed Band Configuration

3.2.1 Microhard Transparent Mode

The following table lists the supported factory default commands available for Microhard Transparent Mode. Use the listed Factory Default command for the unit type required. The same command would be entered into each unit to be configured. See below for additional registers that may be required.

Microhard Systems Transparent Mode				
Radio Model	Protocol	BW	Factory Default	Notes
L400, nL400, SDR400	Microhard Transparent	25 kHz	AT&F51	No repeaters. Adjust link rate, BW using Table 3-2. Use S231 for data buffering.
L400, nL400, SDR400	Microhard Transparent	25 kHz	AT&F52	With repeaters (S141=1), CSMA is enabled, S51 is used. Adjust link rate, BW using Table 3-2. Use S231 for data buffering.
L400, nL400	Pacific Crest and Trim-talk compatible firmware (AT&F2, S103, S125 for Pacific Crest Transparent with EOT Timeout)	12.5 kHz	AT&F62	Rate 4.8kbps, FEC on, Note 1.
		25 kHz	AT&F53	Rate 9.6kbps, FEC on, Note 1.
L400, nL400	Pacific Crest and Trim-talk compatible firmware (AT&F2, S186=2, S103, S125 for Trim-talk 450S).	12.5 kHz	AT&F63	Rate 4.8kbps, S103, S125, Note 2.
		25 kHz	AT&F54	Rate 9.6kbps, S103, S125, Note 2.

Table 3-1: Transparent Mode Factory Defaults

Notes:

1. Use PC-specific registers: S107, S190, S231 and common NB registers: S51, S136, S137, S138, S185 for enhancing.
2. Use Trimtalk-specific registers: S187, S188, S189, S227 and common NB registers: S51, S136, S137, S138, S185 for enhancing.

Registers Applicable to Low Latency Transparent Mode:

The following registers may also need to be configured to enable end-to-end communication between devices. For additional information about a specific register, and its supported values please refer to *Section 6: Register/Command Reference*.

- S102 Serial baud rate (Should match end device)
- S105 Local unit address (Each unit must have a unique unit address)**
- S108 Transmit power in dBm (Minimum required value should be used)
- S123 Averaged RSSI during receiving valid packets
- S131 Tx channel number, edited in channel table
- S132 Rx channel number, edited in channel table
- S191 Repeater Tx channel, edited in channel table
- S192 Repeater Rx channel, edited in channel table
- S142 Serial Channel Mode, select between RS232 (default) and RS485 modes.
- S223 Minimum RSSI value recorded since the unit was placed in Data Mode.
- S224 Maximum RSSI value recorded since the unit was placed in Data Mode.
- S231 Data Buffering Mode

3.0 400 MHz Licensed Band Configuration

3.2.2 Modulation & Link Rate Considerations

The SDR400 in the Narrowband (NB) modem type configuration supports the frequency range of 410-480 MHz. The following table displays the allowed combinations of link rates, modulation schemes and channel bandwidth:

Supported Link Rates/Bandwidth - Microhard Transparent Mode				
Link rate, bps	Register S103	BW 6.25 kHz	BW 12.5 kHz	BW 25 kHz
1200	0	*	*	*
2400	1	*	*	*
3600	2	*	*	*
4800	3		*	*
7200	4		*	*
9600	5		*	*
14400	6			*
19200	7			*
16000	8			*

Table 3-2: Modulation & Link Rates

Before going on-line from AT-command menu, the modem will check if the selected combination of protocol, link rate, BW & modulation scheme are supported. If not supported, the modem will not go on-line.

For quick reference the follow registers are used to modify the Modulation Type, Link Rate and the BW (Channel Space).

Modulation Type **S127** = 0 - 2FSK
= 1 - 4FSK

Link Rate **S103** = 0 - 1200
= 1 - 2400
= 2 - 3600
= 3 - 4800
= 4 - 7200
= 5 - **9600**
= 6 - 14400
= 7 - 19200
= 8 - 16000

Occupied Bandwidth **S125** = 0 - 6.25 kHz
= 1 - 12.5 kHz
= 2 - **25 kHz**

3.0 400 MHz Licensed Band Configuration

3.3 Pacific Crest Models

The SDR400 is compatible with several GPS Transceiver Models by Pacific Crest. Specifically we have developed and tested compatibility with the following models.

- PDL High Power Base, Low Power Base
- ADL Sentry, Vantage, Foundation

Although users can manually configure the SDR400 to be compatible with these models, we have provided factory default commands to simplify this configuration. Select the model in which the SDR400 needs to communicate with and enter the Factory Command.

Pacific Crest Factory Default Commands				
Model	Protocol	BW	Factory Default	Notes
PDL High Power Base, PDL Low Power Base	Transparent with EOT Timeout (PC), 2FSK	12.5 kHz	AT&F62	Rate 4.8kbps, FEC On, use S105 if S190=1, S141 for CSMA. Note 1.
		25 kHz	AT&F53	Rate 9.6kbps, FEC On, use S105 if S190=1, S141 for CSMA. Note 1.
	Trimtalk 450S, 2FSK	12.5 kHz	AT&F63	Rate 4.8kbps. Note 2.
		25 kHz	AT&F54	Rate 9.6kbps. Note 2.
ADL Sentry, Vantage	Pacific Crest Transparent with EOT Timeout, GMSK	12.5 kHz	AT&F62	Rate 4.8kbps, FEC On, use S105 if S190=1, S141 for CSMA. Note 1.
		25 kHz	AT&F53	Rate 9.6kbps, FEC On, use S105 if S190=1, S141 for CSMA. Note 1.
	Pacific Crest Transparent with EOT Timeout, 4FSK, Scrambler control On	12.5 kHz	AT&F64	Rate 9.6kbps, FEC On, use S105 if S190=1, S141 for CSMA, Compatibility Type 1 (register S226=1). Note 1.
		25 kHz	AT&F65	Rate 19.2kbps, FEC On, use S105 if S190=1, S141 for CSMA, Compatibility Type 1 (register S226=1). Note 1.
	Pacific Crest Transparent FST	12.5 kHz	AT&F66	Rate 9.6kbps, FEC on, Compatibility Type 1 (register S226=1).
		25 kHz	AT&F67	Rate 19.2kbps, FEC on, Compatibility Type 1 (register S226=1).
	Trimtalk 450S, GMSK	12.5 kHz	AT&F63	Rate 4.8kbps, see Table 3 if your system has repeaters. Note 2.
		25 kHz	AT&F54	Rate 9.6kbps, see Table 3 if your system has repeaters. Note 2.
	Satel 3AS	12.5 kHz	AT&F60	Rate 9.6kbps, Compatibility Type 1 (register S226=1). Note 3.
		25 kHz	AT&F61	Rate 19.2kbps, Compatibility Type 1 (register S226=1). Note 3.

Table 3-3: Pacific Crest Factory Defaults

Notes:

1. Use PC-specific registers: S107, S190, S231 and common NB registers: S51, S136, S137, S138, S185 for enhancing.
2. Use Trimtalk-specific registers: S187, S188, S189, S227 and common NB registers: S51, S136, S137, S138, S185 for enhancing.
3. Use Satel-specific registers: S129, S226 and common NB registers: S51, S136, S137, S138, S185 for enhancing.

3.0 400 MHz Licensed Band Configuration

Pacific Crest Factory Default Commands (Con't)				
Model	Protocol	BW	Factory Default	Notes
ADL Foundation	Pacific Crest Transparent with EOT Timeout GMSK	12.5 kHz	AT&F62	Rate 4.8kbps, FEC On, use S105 if S190=1, S141 for CSMA. Note 1.
		25 kHz	AT&F53	Rate 9.6kbps, FEC On, use S105 if S190=1, S141 for CSMA. Note 1.
	Pacific Crest Transparent with EOT Timeout, 4FSK, Scrambler control On	12.5 kHz	AT&F64	Rate 9.6kbps, FEC On, use S105 if S190=1, S141 for CSMA, Compatibility Type 1 (register S226=1). Note 1.
		25 kHz	AT&F65	Rate 19.2kbps, FEC On, use S105 if S190=1, S141 for CSMA, Compatibility Type 1 (register S226=1). Note 1.
	Pacific Crest Transparent FST	12.5 kHz	AT&F66	Rate 9.6kbps, FEC on, Compatibility Type 1 (register S226=1).
		25 kHz	AT&F67	Rate 19.2kbps, FEC on, Compatibility Type 1 (register S226=1).
	Trimtalk 450S, GMSK	12.5 kHz	AT&F63	Rate 4.8kbps. Note 2.
		25 kHz	AT&F54	Rate 9.6kbps. Note 2.
	Satel 3AS	12.5 kHz	AT&F60	Rate 9.6kbps, Compatibility Type 1 (register S226=1). Note 3.
		25 kHz	AT&F61	Rate 19.2kbps, Compatibility Type 1 (register S226=1). Note 3.

Table 3-3: Pacific Crest Factory Defaults (Continued)

Notes:

1. Use PC-specific registers: S107, S190, S231 and common NB registers: S51, S136, S137, S138, S185 for enhancing.
2. Use Trimtalk-specific registers: S187, S188, S189, S227 and common NB registers: S51, S136, S137, S138, S185 for enhancing.
3. Use Satel-specific registers: S129, S226 and common NB registers: S51, S136, S137, S138, S185 for enhancing.

ADL (Pacific Crest) 450s vs SDR400 Equivalent Modes		
ADL radio modem (Trimtalk 450S)	Factory defaults	Notes
Base/Rover without Repeaters	AT&F54	
Repeater 1 (1 repeater in chain)	AT&F55	For data sequence number usage use register S187, for stripping off additional information added by repeaters use register S188, for enabling uplink use register S189.
Repeater 2 (2 repeaters in chain)	AT&F56	For data sequence number usage use register S187, for stripping off additional information added by repeaters use register S188, for enabling uplink use register S189.
Base with Repeaters	AT&F57	For data sequence number usage use register S187, for stripping off additional information added by repeaters use register S188, for enabling uplink use register S189.

Table 3-4: Pacific Crest ADL Repeater Modes

3.0 400 MHz Licensed Band Configuration

3.4 Trimble Models

The SDR400 is compatible with several GPS Transceiver Models by Trimble. Specifically we have developed and tested compatibility with the following models.

- TDL 450L (H)
- PDL 450
- HPB 450



Please contact our technical support team if you have radio compatibility problems, we are working on extending of the list of compatible modes

Although users can manually configure the SDR400 to be compatible with these models, we have provided factory default commands to simplify this configuration. Select the model in which the SDR400 needs to communicate with and enter the Factory Command. If any additional registers are required, it will be noted in the table.

Trimble Factory Default Commands				
Model	Protocol	BW	Factory Default	Notes
TDL 450L(H)	Transparent with EOT Timeout Pacific Crest, GMSK, Scrambler control On	12.5 kHz	AT&F62	Rate 4.8kbps, FEC On, use S105 if S190=1, S141 for CSMA. Note 1.
		25 kHz	AT&F53	Rate 9.6kbps, FEC On, use S105 if S190=1, S141 for CSMA. Note 1.
	Transparent with EOT Timeout Pacific Crest, 4FSK, Scrambler control On	12.5 kHz	AT&F64	Rate 9.6kbps, FEC On, use S105 if S190=1, S141 for CSMA, Compatibility Type 1 (register S226=1). Note 1.
		25 kHz	AT&F65	Rate 19.2kbps, FEC On, use S105 if S190=1, S141 for CSMA, Compatibility Type 1 (register S226=1). Note 1.
	Trimtalk 450S, GMSK	12.5 kHz	AT&F63	Rate 4.8kbps, see Table 3 if your system has repeaters. Note 2.
		25 kHz	AT&F54	Rate 9.6kbps, see Table 3 if your system has repeaters. Note 2.
	3AS, Satel	12.5 kHz	AT&F60	Rate 9.6kbps, Compatibility Type 1 (register S226=1). Note 3.
		25 kHz	AT&F61	Rate 19.2kbps, Compatibility Type 1 (register S226=1). Note 3.
	Pacific Crest Transparent FST	12.5 kHz	AT&F66	Rate 9.6kbps, FEC on, Compatibility Type 1 (register S226=1).
		25 kHz	AT&F67	Rate 19.2kbps, FEC on, Compatibility Type 1 (register S226=1).
PDL 450 HPB 450	Pacific Crest Transparent with EOT Timeout, GMSK	12.5 kHz	AT&F62	Rate 4.8kbps, FEC On, use S105 if S190=1, S141 for CSMA. Note 1.
		25 kHz	AT&F53	Rate 9.6kbps, FEC On, use S105 if S190=1, S141 for CSMA. Note 1.
	Trimtalk 450S, GMSK	12.5 kHz	AT&F63	Rate 4.8kbps. Note 2.
		25 kHz	AT&F54	Rate 9.6kbps. Note 2.

Table 3-5: Trimble Factory Defaults

Notes:

1. Use PC-specific registers: S107, S190, S231 and common NB registers: S51, S136, S137, S138, S185 for enhancing.
2. Use Trimtalk-specific registers: S187, S188, S189, S227 and common NB registers: S51, S136, S137, S138, S185 for enhancing.
3. Use Satel-specific registers: S129, S226 and common NB registers: S51, S136, S137, S138, S185 for enhancing.

3.0 400 MHz Licensed Band Configuration

TDL450 (Trimble) vs SDR400 Equivalent Modes		
Trimble radio modem (TDL450/Trimtalk 450S)	Factory defaults	Notes
Base/Rover without Repeaters	AT&F54	
Repeater 1 (1st repeater in chain)	AT&F55	For data sequence number usage use register S187, for stripping off additional information added by repeaters use register S188, for enabling uplink use register S189.
Repeater 2 (2nd repeater in chain)	AT&F56	For data sequence number usage use register S187, for stripping off additional information added by repeaters use register S188, for enabling uplink use register S189.
Base with Repeaters	AT&F57	For data sequence number usage use register S187, for stripping off additional information added by repeaters use register S188, for enabling uplink use register S189.

Table 3-6: Trimble TDL450 Repeater Modes

3.0 400 MHz Licensed Band Configuration

3.5 Satel Models

The SDR400 is compatible with several GPS Transceiver Models by Satel. Specifically we have developed and tested compatibility with the following models.

- Sateline-M3-TR1
- Sateline-M3-TR3

Although users can manually configure the SDR400 to be compatible with these models, we have provided factory default commands to simplify this configuration. Select the model in which the SDR400 needs to communicate with and enter the Factory Command. If any additional registers are required, it will be noted in the table.



Please contact our technical support team if you have radio compatibility problems, we are working on extending of the list of compatible modes

Factory Default Settings for Satel Models				
Model	Protocol	BW	Factory Default	Notes
Satellite-M3-TR1	Pacific Crest Transparent with EOT Timeout GMSK (Option 2), 3AS's FEC off	12.5 kHz	AT&F62	Rate 4.8kbps, FEC On, use S105 if S190=1, S141 for CSMA. Note 1.
		25 kHz	AT&F53	Rate 9.6kbps, FEC On, use S105 if S190=1, S141 for CSMA. Note 1.
	Pacific Crest Transparent with EOT Timeout 4FSK (Option 1), 3AS's FEC off	12.5 kHz	AT&F64	Rate 9.6kbps, FEC on, Compatibility Type 0 (register S226=0).
		25 kHz	AT&F65	Rate 19.2kbps, FEC on, Compatibility Type 0 (register S226=0).
	Trimtalk 450S GMSK (Option 3), 3AS's FEC off	12.5 kHz	AT&F63	Rate 4.8kbps, S227 = 0. Note 2.
		25 kHz	AT&F54	Rate 9.6kbps, S227 = 0. Note 2.
	Satel 3AS, 3AS's FEC on	12.5 kHz	AT&F58	Rate 9.6kbps, Compatibility Type 0 (register S226=0). Note 3.
		25 kHz	AT&F59	Rate 19.2kbps, Compatibility Type 0 (register S226=0). Note 3.
Satellite-M3-TR3	Pacific Crest Transparent with EOT Timeout GMSK (Option 2), 3AS's FEC off	12.5 kHz	AT&F62	Rate 4.8kbps, FEC On, use S105 if S190=1, S141 for CSMA. Note 1.
		25 kHz	AT&F53	Rate 9.6kbps, FEC On, use S105 if S190=1, S141 for CSMA. Note 1.
	Pacific Crest Transparent with EOT Timeout 4FSK (Option 1), 3AS's FEC off	12.5 kHz	AT&F64	Rate 9.6kbps, FEC on, Compatibility Type 0 (register S226=0).
		25 kHz	AT&F65	Rate 19.2kbps, FEC on, Compatibility Type 0 (register S226=0).
	Pacific Crest Transparent FST (Option 5), 3AS's FEC off	12.5 kHz	AT&F68	Rate 9.6kbps, FEC on, Compatibility Type 2 (register S226=2).
		25 kHz	AT&F69	Rate 19.2kbps, FEC on, Compatibility Type 2 (register S226=2).
	Trimtalk 450S GMSK (Options 3,4), 3AS's FEC off	12.5 kHz	AT&F63	Rate 4.8kbps, set register S127 = 1. Note 2.
		25 kHz	AT&F54	Rate 9.6kbps, set registers S226=1, S127 = 1. Note 2.
	Satel 3AS, 3AS's FEC on	12.5 kHz	AT&F58	Rate 9.6kbps, Compatibility Type 0 (register S226=0). Note 3.
		25 kHz	AT&F59	Rate 19.2kbps, Compatibility Type 0 (register S226=0). Note 3.

Table 3-7: Satel Factory Defaults

Notes:

1. Use PC-specific registers: S107, S190, S231 and common NB registers: S51, S136, S137, S138, S185 for enhancing.
2. Use Trimtalk-specific registers: S187, S188, S189, S227 and common NB registers: S51, S136, S137, S138, S185 for enhancing.
3. Use Satel-specific registers: S129, S226 and common NB registers: S51, S136, S137, S138, S185 for enhancing.

3.0 400 MHz Licensed Band Configuration

SDR400 & Trimtalk 450S Protocol by M3-TR1/M3-TR3 Compatibility				
Radio	Mode	BW	S226	S227
M3-TR1	Trimtalk 450S	12.5kHz	0	0
		25kHz	0	0
M3-TR3	Trimtalk 450S (T & P)	12.5kHz	0	1
		25kHz	1	1

Table 3-8: SDR400 Compatibility for Trimtalk Protocol 450S by Satellite M3-TR1/M3-TR3

4.0 900 MHz Frequency Hopping Configuration

To begin configuration, the SDR400 must be mounted into either a Microhard supplied development board (with factory attached interface card), or be mounted into a customer designed platform. The SDR400 is configured using AT commands through the **Data** port, or using special diagnostic commands through the **Diagnostic** Port. Refer to **Section 2: Hardware Description** for information related to inter-facing to, or powering the module.

To issue AT commands through the **Data** port, the SDR400 must first be set into **Command Mode** as de-scribed below.

4.1 Configuration/Unit Modes

4.1.1 Command Mode

- the SDR400 module is offline (data is not passing through the unit via it's local data lines or RF communications)
- if installed in a Development Board, the only LED illuminated will be the blue power LED.
- the SDR400's configuration options (registers) may be viewed and modified using AT commands.

Two methods are typically used to place the SDR400 Series into Command Mode.

1. Force to Command Mode

- Power down off the Development Board assembly.
- Connect a 9-pin straight-through serial cable from the PC serial port to the rear RS-232 port (DATA) of the modem.
- Launch a terminal communications program (e.g. HyperTerminal) and configure for 9600bps, 8 data bits, No parity, 1 stop bit (8N1), no flow control
- press and hold the CONFIG button
- continue to press the CONFIG button and apply power to the modem
- release the CONFIG button
- On power up the terminal session window should show "NO CARRIER OK" as seen below:

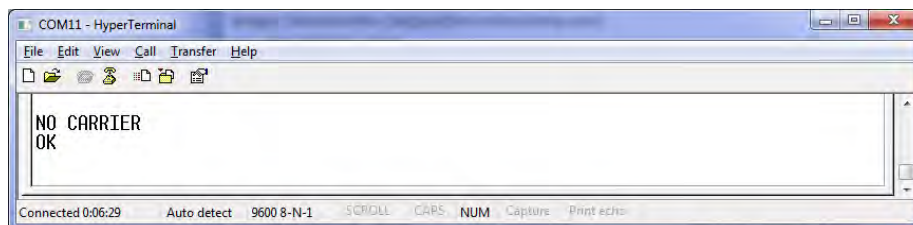

Image 4-1: Command Mode

- the SDR400 is now in command mode, and AT commands can be used to configure or query the settings. AT&V will display the current configuration, and the registers can be queried using the AT&XXX=? Command where XXX = the register number. Help is available using the AT&XXX /? Command.
- Any and all changes must be written to NVRAM using the AT&W command.

4.0 900 MHz Frequency Hopping Configuration

2. Escape from Data Mode

- With the SDR400 powered up and 'online', connect a 9-pin straight-through serial cable from the PC serial port to the RS-232 DATA port on the dev board.
- Launch a terminal program (e.g. HyperTerminal) and configure for the SDR400's established serial baud rate parameters (PC & modem must match).
- Pause 1 second, type '+++', pause 1 second: the monitor should show the module response of 'NO CARRIER OK'

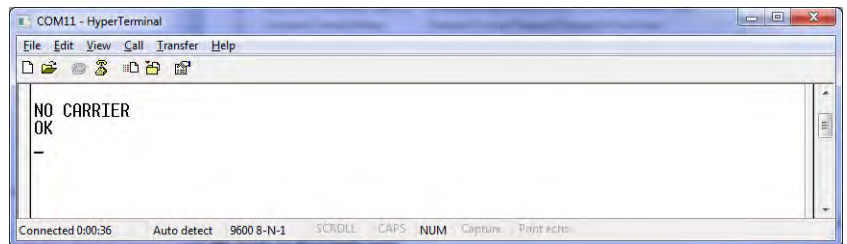

Image 4-2: Command Mode

- The SDR400 is now in command mode, and AT commands can be used to configure or query the settings.
- Entering the AT&V command as shown will show the current configuration as seen below: (The data displayed varies based on network and unit type.)

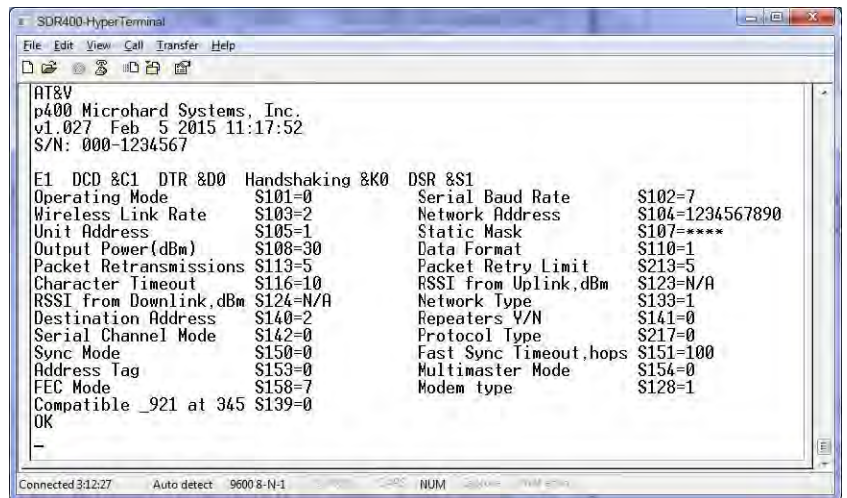

Image 4-3: Command Mode - AT&V Display

4.1.2 Data Mode

Data Mode is the normal operational state of all deployed SDR400 modules. In this mode the module is prepared to exchange data as per its configuration settings. Available LED indications can provide an indication of the data exchange (TX and RX LEDs).

To enter DATA mode from COMMAND mode, enter the command: **ATA [Enter]**

4.0 900 MHz Frequency Hopping Configuration

4.1.3 Modem Type (S128)

The SDR400 is a Multi-Frequency Modem that is capable of operating in one of three (3) different modem types. The three different modem types of the SDR400 are (1) 400 MHz Narrowband Licensed Band Mo-dem, (2) 900 MHz FHSS modem operating in the 900 MHz ISM band and (3) as a 400 MHz Frequency Hopping Modem. It is important to set the correct modem type before commencing with any additional configuration parameters.

This section describes the configuration of a modem that has been set to operate as a 900 MHz Frequency Hopping Spread Spectrum Modem (FHSS), operating in the 902.4 to 927.6 MHz ISM Band. The SDR400 in 900 MHz mode is compatible with MHX920 and n920 radios from Microhard Systems.

The modem type can be selected using the register S128 (Modem Type) as follows:



Registers can be changed by entering the AT command as seen below:

Example:
ATS128=1 <enter>

Any registers that are changed must be written to flash using the **AT&W** command>

Modem Type **S128** = 0 - 400 MHz Narrow Band (NB) Modem
= **1 - 900 MHz Frequency Hopping (FH) Modem**
= 2 - 400 MHz Frequency Hopping (FH) Modem *

* 400 MHz FHSS is an order option (C2S or C1S) and must be specified at time of order and enabled at the factory.

The following image shows the current options for the modem type as described above.

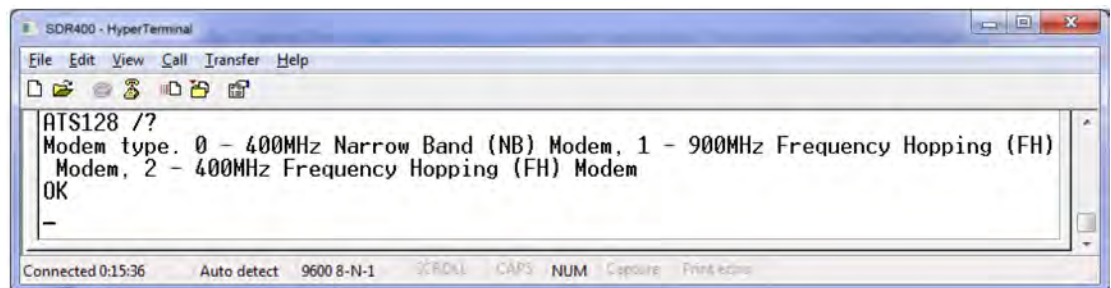

Image 4-4: Modem Type S128

4.1.4 Network Type (S133)

Once configured to operate as a 900 MHz FHSS modem, the Network Type must be decided and planned for a successful deployment. The SDR400 currently supports Point to Point, Point to Multipoint network topologies.

To change the network type the register S133 (Network Type) is used as seen below:

Network Type **S133** = **0 - Point to Multipoint**
= 1 - Point to Point
= 2 - Peer to Peer
= (Additional Modes may be available)

Ensure the correct network type is set before proceeding. It is recommended to start with the factory default settings to aid in initial configuration (discussed later), and then changing registers as required.

4.0 900 MHz Frequency Hopping Configuration

4.1.5 900 MHz Frequency Hopping

FCC requires that FHSS systems hop on 50 different channels within the 900 ISM Band. The maximum time spent on any one channel must not exceed 400ms.

To calculate the center frequency represented by each channel only the starting frequency and the size of each channel (Channel Bandwidth) need to be known. For the 900 MHz ISM Band, the starting frequency is 902.4 MHz, and the Channel Bandwidth is dependent on the current link rate.

$$\text{Freq channel } n = 902.4 + ((n-1) \times \text{BW})\text{MHz.}$$

Example: Channel 75 @ 172 kbps = $902.4 + ((75-1) \times 0.280)$ MHz
 $902.4 + (74 \times 0.280)$ MHz
 $902.4 + 20.72$ MHz
 923.12 MHz

Link Rate (kbps)	Channel Bandwidth (kHz)
19.2	280
24.6	280
57.6	280
115.2	280
172.8	280
230.4	280
276.4	400
345.6	400

Table 4-1: Link Rate & BW

4.0 900 MHz Frequency Hopping Configuration

4.2 Point to Point Network

In a point-to-point network, a path is created to transfer data between Point A and Point B, where Point A may be considered the Master modem and Point B a Slave. Such a PTP network may also involve one or more Repeaters (in a store-and-forward capacity) should the radio signal path dictate such a requirement. Point to Point is enabled by setting register S133 to 1 (*ATS133=1, Network Type*).

A PTP configuration may also be used in a more dynamic sense: there may be many Slaves (and Repeaters) within such a network, however the Master may have its 'Destination Address' (S140) changed when required to communicate with a specific Slave.

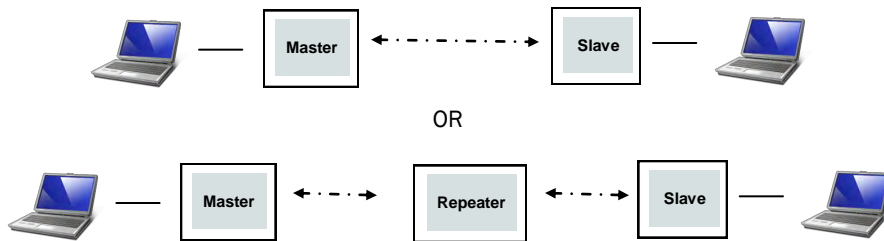

Drawing 4-1: Point to Point Network Topology

4.2.1 Operating Modes / Unit Types

In a Microhard Point to Point Network, three unit types or operating modes are available: the Master, Repeater, and the Remote. The **Masters** role is to provide network synchronization for the system, which ensures all units are active and able to communicate as required. The Master controls the flow of data through the system; all data passes through it. The diagram below shows a unit configured as a Master.

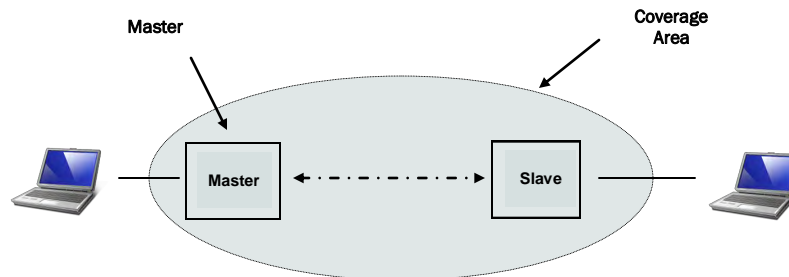

Drawing 4-2: Point to Point Master

4.0 900 MHz Frequency Hopping Configuration

Repeaters can be used to extend the coverage of the Master. Required only if necessary to establish a radio path between a Master and Slave(s); stores and forwards data sent to it. Synchronizes to Master and provides synchronization to 'downstream' units. If a local device is attached to a Repeater's serial data port, the Repeater will also behave as a Slave (aka Repeater/Slave).

Adding one or more Repeaters within a network will cut the overall throughput of the network in **half**; the throughput is halved only once, i.e. it does not decrease with the addition of more Repeaters. If there is a 'path' requirement to provide Repeater functionality, but throughput is critical, a work around is to place two modems at the Repeater site in a 'back-to-back' configuration. One modem would be configured as a Slave in the 'upstream' network; the other a Master (or Slave) in the 'downstream' network. Local connection between the modems would be a 'null modem' cable. Each modem would require its own antenna; careful consideration should be given with respect to antenna placement and modem configuration.

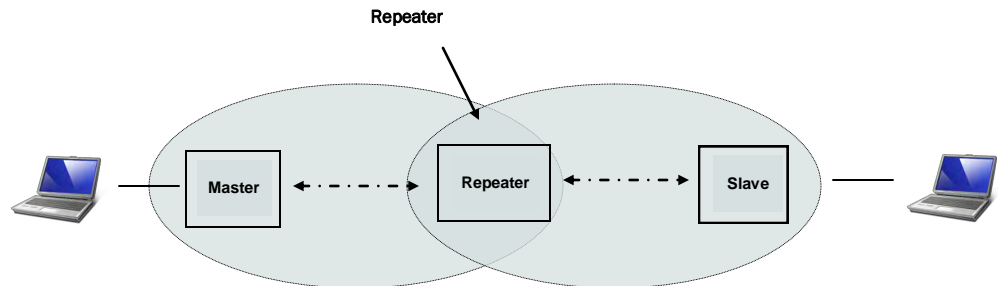

Drawing 4-3: Point to Point Repeater

A **Slave (Remote)** is an endpoint/node within a network to which a local device is attached. Communicates with Master either directly or through one or more Repeaters.

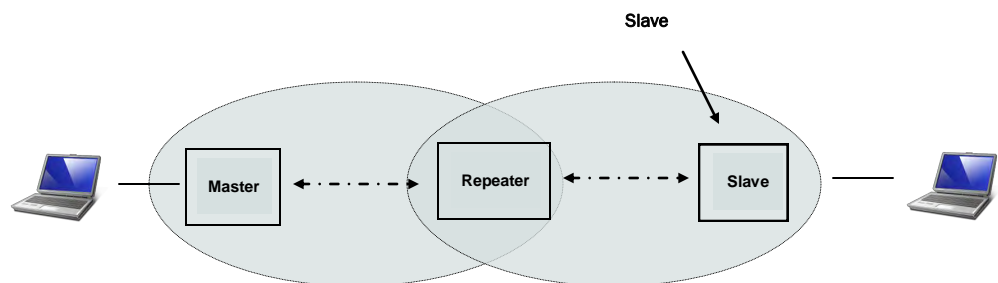

Drawing 4-4: Point to Point Slave

Units can be configured to perform the various roles discussed by setting register S101 as follows:

- ATS101 = 0 - Master
- ATS101 = 1 - Repeater
- ATS101 = 2 - Slave (Remote)

4.0 900 MHz Frequency Hopping Configuration

4.2.2 Configuration Using Factory Defaults

Factory default setting commands can be used to aid in the configuration and deployment of the SDR400 modules, providing a known starting point in the configuration process for each unit type. Using the factory default commands sets all applicable registers to factory recommended settings and allows for initial connectivity between units. Configuring modems using the factory default settings have the following benefits:

- hastens the configuration process - *load default settings and, if necessary, apply only minor settings / adjustments*
- aids in troubleshooting - *if settings have been adjusted and basic communications cannot be established, simply revert to the factory default setting and any improper adjustments will be overwritten and a 'fresh start' can be made with known-to-work settings*

For many networks, the factory default commands may be all that is necessary to configure and deploy a simple Point to Point Network. Other applications may require additional registers to be configured. Regardless of the complexity of the configuration, the factory default settings provide a starting point for all configurations. All unit types have a factory default setting command.

AT&F6	-	Point to Point Master (Fast - 172kbps)
AT&F7	-	Point to Point Slave (Fast)
AT&F8	-	Point to Point Master (Slow - 19.2kbps)
AT&F9	-	Point to Point Slave (Slow)

The screen shots for each unit type highlight the key registers that are automatically changed to create a Point to Point configuration. There may also be additional registers such as the Network ID that are recommended to be changed.



Each PTP Network must have a unique network ID. This can be changed using register S104: Network Address.

```
SDR400-HyperTerminal
File Edit View Call Transfer Help
Frequency Hopping (FH) modems
AT&F ??
&F1 - FH Master Fast PMP
&F2 - FH Slave Fast PMP
&F3 - FH Repeater Fast PMP
&F4 - FH Master Slow PMP
&F5 - FH Slave Slow PMP
&F6 - FH Master Fast PP
&F7 - FH Slave Fast PP
&F8 - FH Master Slow PP
&F9 - FH Slave Slow PP
&F10 - FH Master Fast PMP no Time ACK
&F11 - FH Master Fast P2P no Time ACK
&F12 - FH Master Fast PP no Time ACK
&F15 - FH Master WL
&F16 - FH Slave WL
&F18 - FH Master Fast TDMA
&F19 - FH Slave Fast TDMA
```

Image 4-5: Frequency Hopping Factory Defaults

4.0 900 MHz Frequency Hopping Configuration

AT&F6 Point to Point Master (Fast)

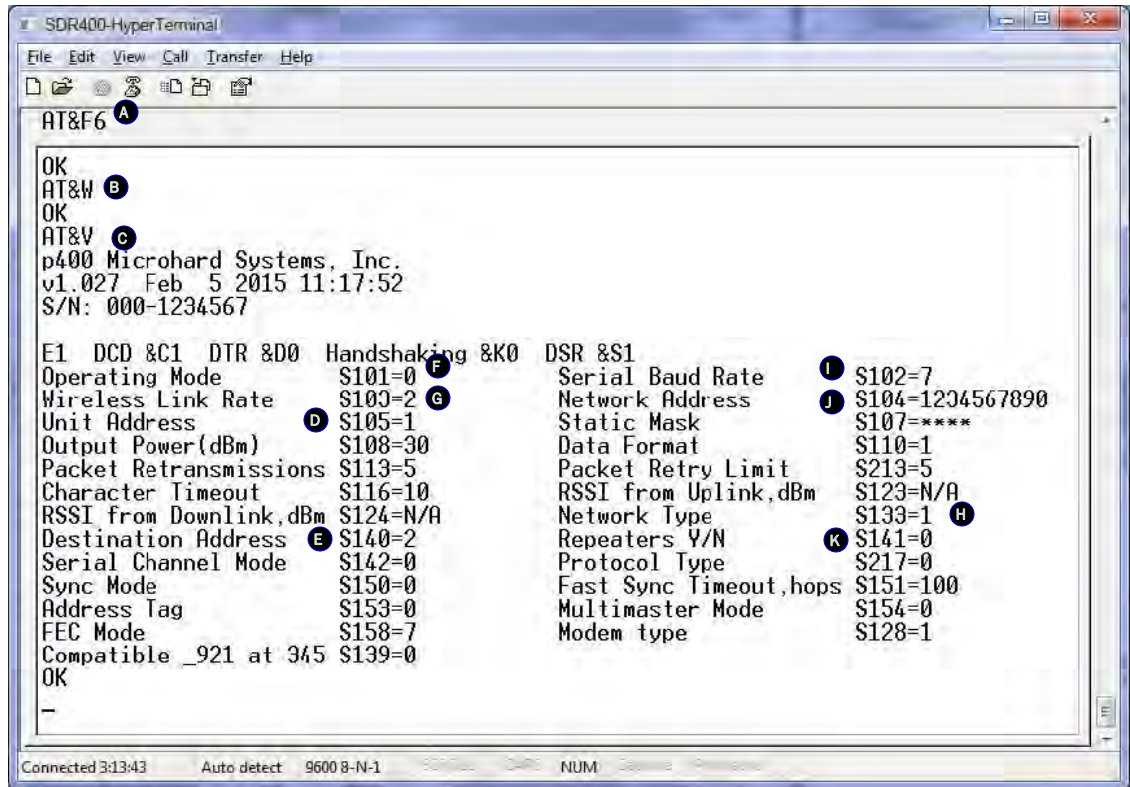

Image 4-6: Factory Defaults AT&F6 - Point to Point Master

- A) AT&F6 - Sets the factory defaults for a Point to Point Master.
- B) AT&W - Writes the changes to NVRAM.
- C) AT&V - Displays the configuration as seen above.
- D) S105 - Every unit in a Point to Point Network must have a unique unit address. The Master is automatically set to 1, and should not be changed.
- E) S140 - The destination address is unit address of the final destination, which all data is to be sent. The address entered would generally be the unit address of the Slave.
- F) S101 - The operating mode defines the unit type and is set to 0, which is a Master.
- G) S103 - Wireless Link Rate must be set to the same value of each unit in the system. Higher link rates may result in higher throughput, but lower link rates usually provide better sensitivity and overall robustness.
- H) S133 - The network type must be set to 1 for Point to Point operation. The content displayed by the AT&V command will vary with the network type.
- I) S102 - The serial baud rate (and data format S110) must match that of the connected device.
- J) S104 - Each unit in a Network must have the same Network Address. It is strongly recommended to never use the default setting of 1234567890. To change the Network Address, the ATS104=XXXXXXX command can be used.
- K) S141 - This register informs the master if 1 or more repeaters are present in the system. This applies only to the master radio.

Remember, anytime registers are changed the values must be written to NVRAM using the AT&W command. To switch from command mode to data mode (online mode), the ATA command can be issued.

4.0 900 MHz Frequency Hopping Configuration

AT&F7 Point to Point Slave (Fast)

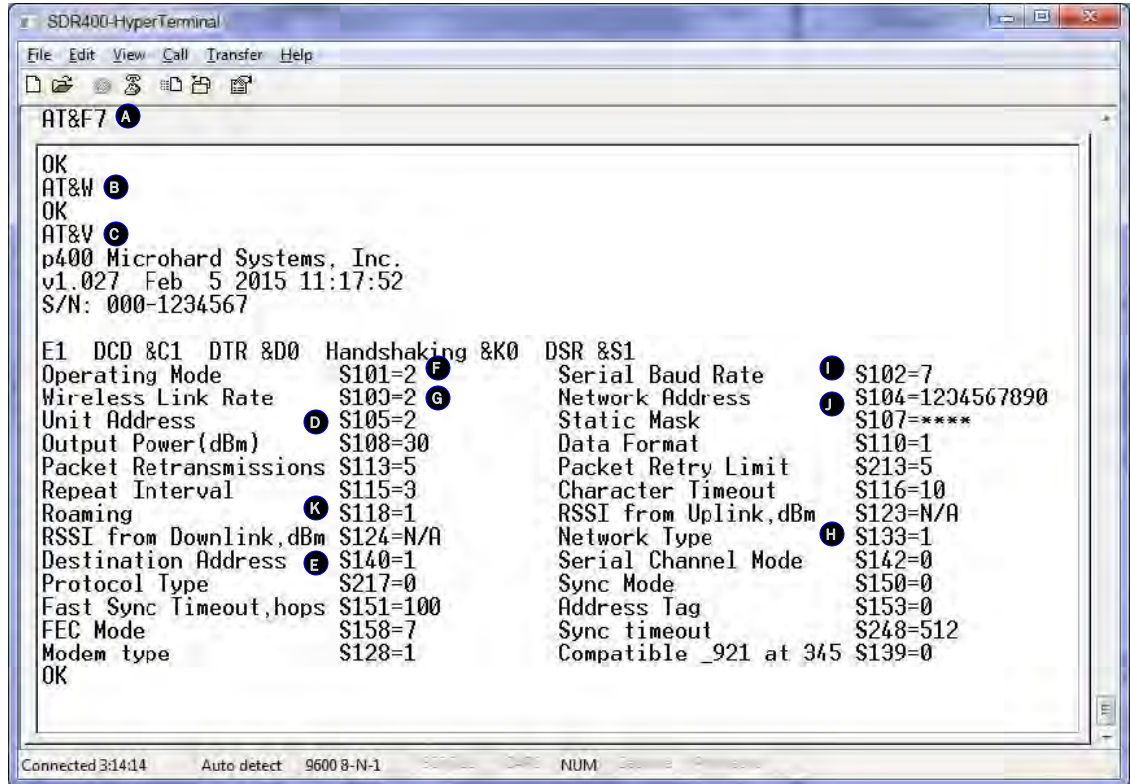

Image 4-7: Factory Defaults AT&F7 - Point to Point Slave

- A) AT&F7 - Sets the factory defaults for a Point to Point Slave.
- B) AT&W - Writes the changes to NVRAM.
- C) AT&V - Displays the configuration as seen above.
- D) S105 - Every unit in a Point to Point Network must have a unique unit address. The address of the slave (remote) is automatically set to 2. *This can be changed, but ensure that the destination address on the master is also changed!*
- E) S140 - The destination address is unit address of the final destination to which all data is to be sent. In a Point to Point Network this address is set to 1, the unit address of the master, and should not be changed.
- F) S101 - The operating mode defines the unit type and is set to 2, which is a Slave (Remote).
- G) S103 - Wireless Link Rate must be set to the same value of each unit in the system.
- H) S133 - The network type must be set to 1 for Point to Point operation. The content displayed by the AT&V command varies with the network type.
- I) S102 - The serial baud rate (and data format S110) must match that of the connected device.
- J) S104 - Each unit in a Network must have the same Network Address. To change the Network Address, the AT S104=XXXXXXX command can be used.
- K) S118 - If the slave is to connect through a repeater, enter the unit address of the repeater here.

4.0 900 MHz Frequency Hopping Configuration

Point to Point Repeater

There is no Factory default mode for a PTP Repeater, the procedure below outlines the steps required to add a repeater to a PTP system.

Note that the Master has a register 'S141 - Repeaters Y/N' and the Slave does not. This register informs the Master of there being one or more Repeaters in this network. The factory defaults assume 'no' and assign a value of 0. If a Repeater is to be installed, and all the Master and Slave defaults will be maintained, following is a procedure on how to configure a Repeater into this fixed (non-mobile) PTP network:

Master

- enter into Command Mode
- change S141 (Repeaters Y/N) to 1 (which means 'Yes')
- save the change using the AT&W command
- go online with the ATA command

Repeater

- enter into Command Mode
- load a third modem with &F7 (PTP Slave factory default settings)
- change the Operating Mode (S101) from 2 (Slave) to 1 (Repeater)
- change the Unit Address (UA) (S105) from 2 to 3
- save the changes using the AT&W command
- go online with the ATA command

Slave

- enter into Command Mode
- change S118 from 1 (the UA of the Master) to 3 (the UA of the Repeater)
- save the change using the AT&W command
- go online with the ATA command

This system may be tested by sending text at 9600bps, 8N1 through the RS-232 serial port of one modem and observing that it appears at the RS-232 serial port of the other modem. The Slave is synchronized to the Repeater, which in turn is synchronized to the Master. If the Repeater is taken offline, in a matter of moments the Slave's RSSI LEDs will indicate that it is 'scanning' for its immediate upstream unit; place the Repeater online and the Slave will quickly acquire it. If the Master is taken offline, both the Repeater and Slave will begin to scan.

4.0 900 MHz Frequency Hopping Configuration

4.2.3 Retransmissions

Packet Retransmissions can be used to ensure data reaches its intended destination by resending the same packet over and over. In Point to Point system all data is acknowledged by the destination, resulting in retransmissions only being used if no acknowledgement is received. The overall impact on system performance, while not as significant as it is in Mesh and Point to Multipoint networks, should still be considered. The more times a modem retransmits data, the more the overall throughput of the system is reduced. To adjust the retransmission rate, use register S113, the default value is 5 (+ the initial transmission).

S113 = 5 - Packet Retransmissions (0-254)

Retransmissions are typically used in noisy environments to combat interference and low signal strength, ensuring data is received at the intended destination.

4.2.4 Network Synchronization

Network Synchronization is what allows all units to hop from frequency to frequency at the same time. For units to synchronize with the network, each unit must have the same:

- Network ID (S104)
- Network Type (S133)

Sync Timeout

Once synchronized to the network the unit does not need to receive sync data often to keep track of where the system is supposed to be (in time and frequency). The sync Timeout defines the number of hops where no sync data is received from a Master and/or Repeater before losing sync. In other words, how long a unit will remain synchronized with the network without receiving any sync packets before it gives up and loses sync.

S248 = 512 Sync Timeout (4-65534)

Setting a value too low will cause the unit to lose sync easily and time will be wasted trying to re-sync to the network. Several hops can go by without receiving a sync packet, and this is completely normal. If this value is set too high, the unit will assume for a long time that the network is still out there, when especially in mobile applications, it may not be.

4.0 900 MHz Frequency Hopping Configuration

4.3 Point to Multipoint Network

In a Point to Multipoint Network, a path is created to transfer data between the Master modem and numerous remote modems. The remote modems may simply be Slaves with which the Master communicates directly, and/or Slaves which communicate via Repeaters. Some or all of the Repeaters may also act as Slaves in this type of Network, i.e. the Repeaters are not only storing and forwarding data, but are also acting as Slaves. Such Repeaters may be referred to as 'Repeater/Slaves'. Point to Multipoint is enabled by setting register S133 to 0 (*ATS133=0, Network Type*).

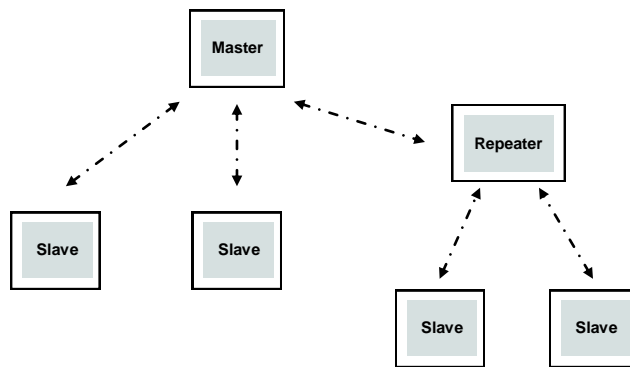

Drawing 5-1: Point to Multipoint Network Topology

4.3.1 Operating Modes / Unit Types

In a Microhard Point to Multipoint Network, three unit types or operating modes are available: the Master, the Repeater, and the Remote. The **Master** modems role is to provide network synchronization for the system, which ensures all units are active and able to communicate as required. The Master controls the flow of data through the system; all data passes through it. The diagram below shows a unit configured as a Master.

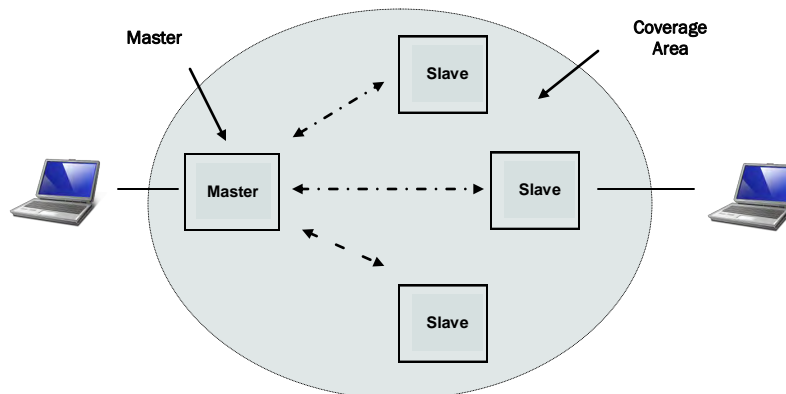

Drawing 5-2: Point to Multipoint Master

4.0 900 MHz Frequency Hopping Configuration

Repeaters can be used to extend the coverage of the Master. Required only if necessary to establish a radio path between a Master and Slave(s); stores and forwards data sent to it. Synchronizes to Master and provides synchronization to 'downstream' units. If a local device is attached to a Repeater's serial data port, the Repeater will also behave as a Slave (aka Repeater/Slave).

Adding one or more Repeaters within a network will cut the overall throughput of the network in **half**; the throughput is halved only once, i.e. it does not decrease with the addition of more Repeaters. If there is a 'path' requirement to provide Repeater functionality, but throughput is critical, a work around is to place two modems at the Repeater site in a 'back-to-back' configuration. One modem would be configured as a Slave in the 'upstream' network; the other a Master (or Slave) in the 'downstream' network. Local connection between the modems would be a 'null modem' cable. Each modem would require its own antenna; careful consideration should be given with respect to antenna placement and modem configuration.

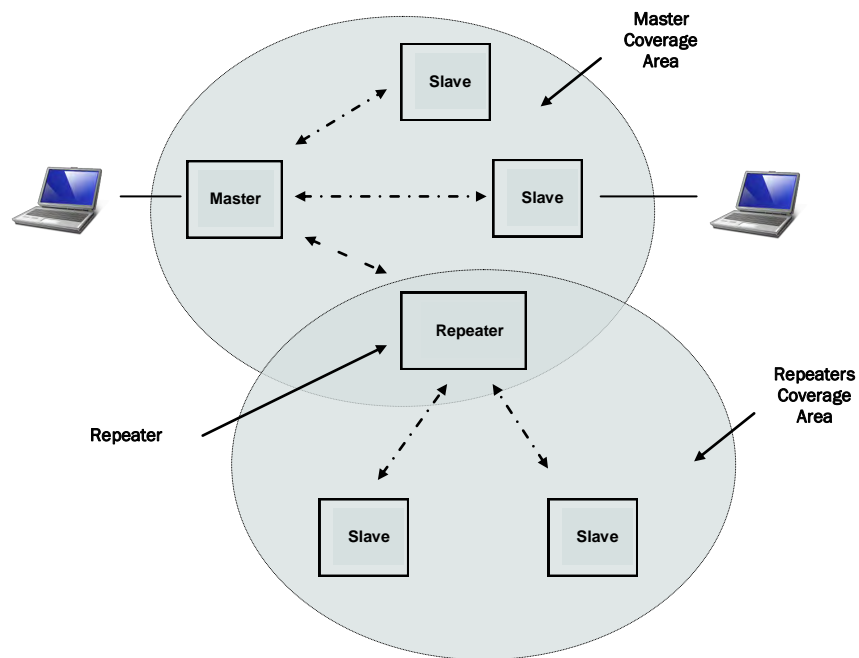

Drawing 5-3: Point to Multipoint Repeater

4.0 900 MHz Frequency Hopping Configuration

A **Slave (Remote)** is an endpoint or node within a network to which a local serial device is attached. Communicates with Master either directly or through one or more Repeaters.

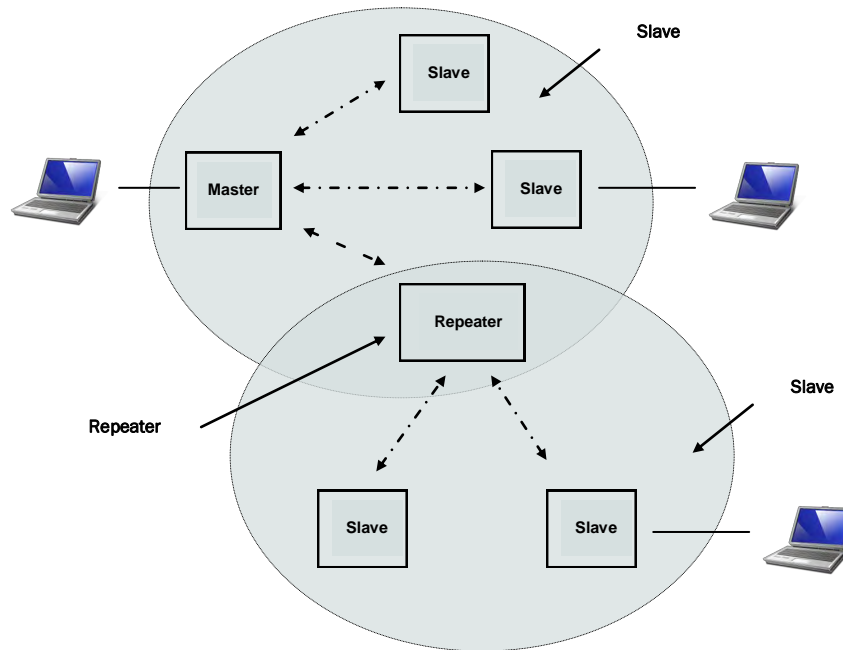

Drawing 5-4: Point to Multipoint Slave

Units can be configured to perform the various roles discussed by setting register S101 as follows:

- ATS101 = 0 - Master
- ATS101 = 1 - Repeater
- ATS101 = 2 - Slave (Remote)

The next section discussed using Factory Default commands to configure the various types of units that are available in a Point to Multipoint network, simplifying the configuration process.

4.0 900 MHz Frequency Hopping Configuration

4.3.2 Configuration Using Factory Defaults

Factory default setting commands can be used to aid in the configuration and deployment of the SDR400 series modules, providing a known starting point in the configuration process for each unit type. Using the factory default commands sets all applicable registers to factory recommended settings and allows initial connectivity between units. Configuring modems using the factory default settings have the following benefits:

- hastens the configuration process - *load default settings and, if necessary, apply only minor settings / adjustments*
- aids in troubleshooting - *if settings have been adjusted and basic communications cannot be established, simply revert to the applicable factory default setting and any improper adjustments will be overwritten and a 'fresh start' can be made with known-to-work settings*

For many networks, the factory default commands may be all that is necessary to configure and deploy a simple Point to Multipoint Network. Other applications may require additional registers to be configured. Regardless of the complexity of the configuration, the factory default settings provide a starting point for all configurations. All PMP unit types have a factory default setting command.

AT&F1	-	Point to Multipoint Master (Fast - 172kbps)
AT&F2	-	Point to Multipoint Slave
AT&F3	-	Point to Multipoint Repeater
AT&F4	-	Point to Multipoint Master (Slow Mode - 19.2kbps)
AT&F5	-	Point to Multipoint Slave

The screen shots for each unit type will highlight the key registers that are automatically changed to create a Point to Multipoint configuration. There may also be additional registers such as the Network ID that are recommended to be changed.



Each PMP Network must have a unique network ID. This can be changed using register S104: Network Address.

```
SDR400-HyperTerminal
File Edit View Call Transfer Help
[Icons]
AT&F ??
Frequency Hopping (FH) modems
&F1 - FH Master Fast PMP
&F2 - FH Slave Fast PMP
&F3 - FH Repeater Fast PMP
&F4 - FH Master Slow PMP
&F5 - FH Slave Slow PMP
&F6 - FH Master Fast PP
&F7 - FH Slave Fast PP
&F8 - FH Master Slow PP
&F9 - FH Slave Slow PP
&F10 - FH Master Fast PMP no Time ACK
&F11 - FH Master Fast P2P no Time ACK
&F12 - FH Master Fast PP no Time ACK
&F15 - FH Master WL
&F16 - FH Slave WL
&F18 - FH Master Fast TDMA
&F19 - FH Slave Fast TDMA
```

Image 5-4: Frequency Hopping Factory Defaults

4.0 900 MHz Frequency Hopping Configuration

AT&F1 Point to Multipoint Master (Fast)

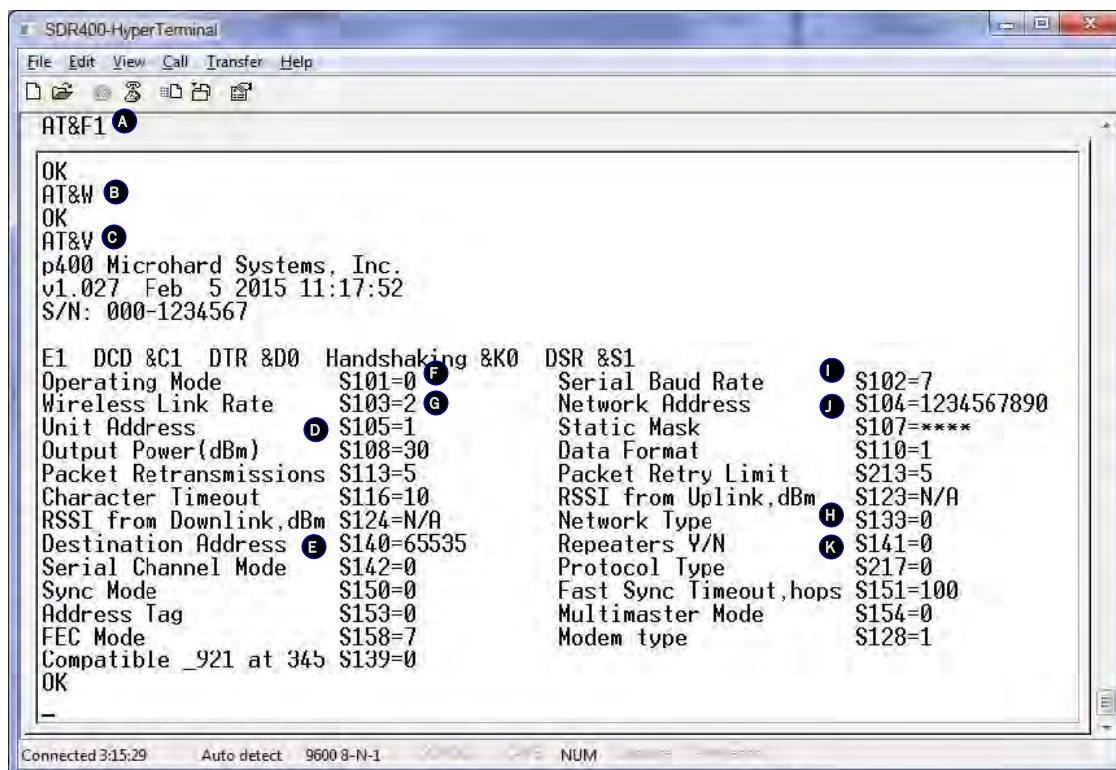

Image 5-5: Factory Defaults AT&F1 - Point to Multipoint Master

- A) AT&F1 - Sets the factory defaults for a Point to Multipoint Master.
- B) AT&W - Writes the changes to NVRAM.
- C) AT&V - Displays the configuration as seen above.
- D) S105 - Every unit in a Point to Multipoint Network must have a unique unit address. The Master is automatically set to 1, and should not be changed.
- E) S140 - The destination address for a PMP Network, by default is 65535, which means data is broadcast from the Master to all other units.
- F) S101 - The operating mode defines the unit type and is set to 0, which is a Master.
- G) S103 - Wireless Link Rate must be set to the same value of each unit in the system. Higher link rates may result in higher throughput, but lower link rates usually provide better sensitivity and overall robustness.
- H) S133 - The network type must be set to 0 for Point to Multipoint operation. The content displayed by the AT&V command will vary with the network type.
- I) S102 - The serial baud rate (and data format S110) must match that of the connected device.
- J) S104 - Each unit in a Network must have the same Network Address. It is strongly recommended to never use the default setting of 1234567890. To change the Network Address, the ATS104=XXXXXXX command can be used.
- K) S141 - This register informs the master if 1 or more repeaters are present in the system. This applies only to the master radio.

Remember, anytime registers are changed the values must be written to NVRAM using the AT&W command. To switch from command mode to data mode (online mode), the ATA command can be issued.

4.0 900 MHz Frequency Hopping Configuration

AT&F2 Point to Multipoint Slave (Fast)

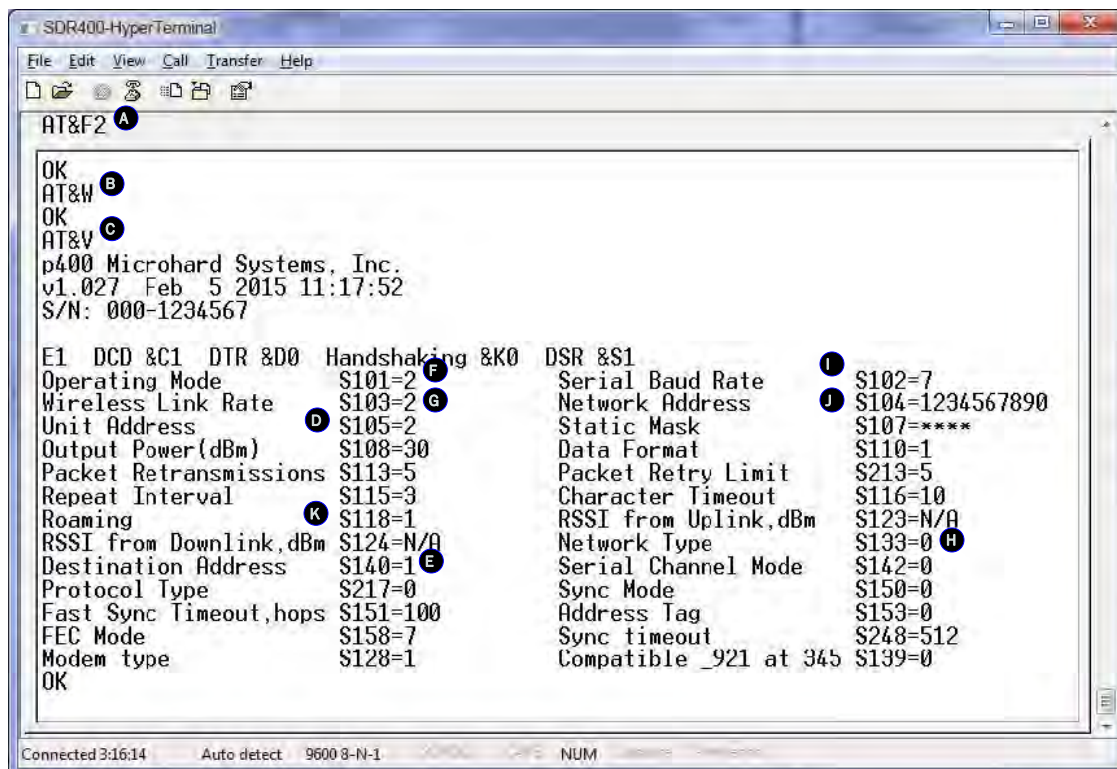

Image 5-6: Factory Defaults AT&F2 - Point to Multipoint Slave

- A) AT&F2 - Sets the factory defaults for a Point to Multipoint Slave.
- B) AT&W - Writes the changes to NVRAM.
- C) AT&V - Displays the configuration as seen above.
- D) S105 - Every unit in a Point to Multipoint Network must have a unique unit address. The address of the slave (remote) is automatically set to 2. If adding more than 1 Slave, this will need to be modified for each unit added.
- E) S140 - The destination address is the final destination to which all data is to be sent. In a Point to Multipoint Network this address is set to 1, the unit address of the Master, and should not be changed.
- F) S101 - The operating mode defines the unit type and is set to 2, which is a Slave (Remote).
- G) S103 - Wireless Link Rate must be set to the same value of each unit in the system.
- H) S133 - The network type must be set to 0 for Point to Multipoint operation.
- I) S102 - The serial baud rate (and data format S110) must match that of the connected device.
- J) S104 - Each unit in a Network must have the same Network Address. To change the Network Address, the AT\$104=XXXXXXX command can be used.
- K) S118 - If the slave is to connect through a repeater, enter the unit address of the repeater here.

4.0 900 MHz Frequency Hopping Configuration

AT&F3 Point to Multipoint Repeater (Fast)

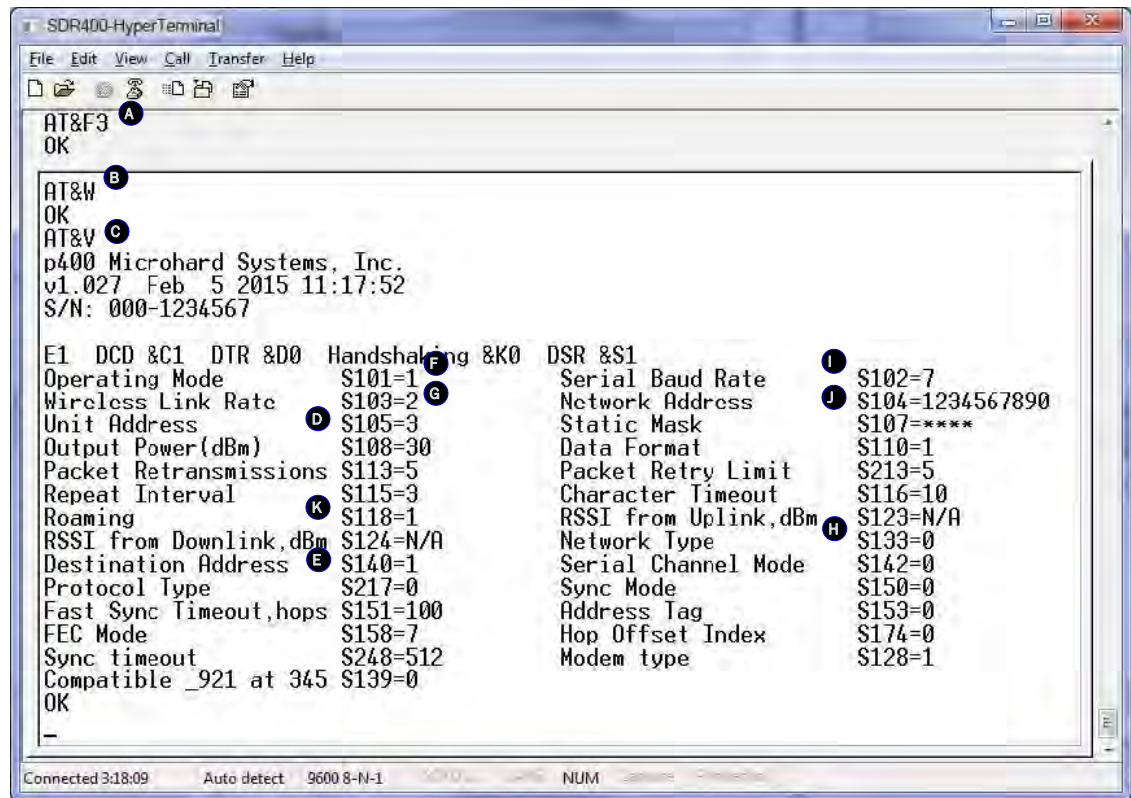

Image 5-7: AT&F3 Point to Multipoint Repeater

- A) AT&F3 - Sets the factory defaults for a Point to Multipoint Repeater.
- B) AT&W - Writes the changes to NVRAM.
- C) AT&V - Displays the configuration as seen above.
- D) S105 - Every unit in a Point to Multipoint Network must have a unique unit address. The address of the Repeater is automatically set to 3.
- E) S140 - The destination address is the final destination to which all data is to be sent. In a Point to Multipoint Network this address is set to 1, the unit address of the Master, and should not be changed.
- F) S101 - The operating mode defines the unit type and is set to 1, which is a Repeater.
- G) S103 - Wireless Link Rate must be set to the same value of each unit in the system.
- H) S133 - The network type must be set to 0 for Point to Multipoint operation.
- I) S102 - The serial baud rate (and data format S110) must match that of the connected device.
- J) S104 - Each unit in a Network must have the same Network Address. To change the Network Address, the `ATS104=XXXXXXX` command can be used.
- K) S118 - If the repeater is to connect through another repeater, enter the unit address of the repeater here.

4.0 900 MHz Frequency Hopping Configuration

4.3.3 Unit Addressing

In a Point to Multipoint Network each unit must have a unique unit address, which can be configured using register S105. Duplicate addresses may result in unpredictable problems in the network. In a PMP Network data flow is such that data from the Master is sent to all units by setting the destination address (S140) to 65535, meaning data is broadcast to all units.

4.3.4 Retransmissions

Packet Retransmissions can be used to ensure data reaches its intended destination by re-sending the same packet over and over. In Point to Multipoint system data is not acknowledged by the destination, meaning data will be transmitted, an additional number of times specified by S113, resulting in a significant impact on system performance. The more times a modem retransmits data, the more the overall throughput of the system is reduced. To adjust the retransmission rate, use register S113, the default value is 5 (+ the initial transmission). Although, this number should be as low as possible to keep as much bandwidth in the system as possible.

S113 = 5 - Packet Retransmissions (0-254)

Retransmissions are typically used in noisy environments to combat interference and low signal strength, ensuring data is received at the intended destination.

4.3.5 Network Synchronization

Network Synchronization is what allows all units to hop from frequency to frequency at the same time.

For units to synchronize with the network, each unit must have the same:

- Network ID (S104)
- Network Type (S133)

Sync Timeout

Once synchronized to the network the unit does not need to receive sync data often to keep track of where the system is supposed to be (in time and frequency). The sync Timeout defines the number of hops where no sync data is received from a Master and/or Repeater before losing sync. In other words, how long a unit will remain synchronized with the network without receiving any sync packets before it gives up and loses sync.

S248 = 100 Sync Timeout (4-65534)

Setting a value too low will cause the unit to lose sync easily and time will be wasted trying to re-sync to the network. Several hops can go by without receiving a sync packet, and this is completely normal. If this value is set too high, the unit will assume for a long time that the network is still out there, when especially in mobile applications, it may not be.

4.0 900 MHz Frequency Hopping Configuration

4.3.6 Point-to-Multipoint TDMA (Standard TDMA)

Time Division Multiple Access (TDMA) is available as a special form of the PMP network topology.

In Standard TDMA mode, a list of remote units is configured in the Master modem, the Master unit then cycles through the list and indicates to the remote when it is able to transmit its data. The remote unit would then begin sending data, if it had data to send, and then release the channel when no longer needed. This would indicate to the master unit to queue the next unit and so on.

In this mode each slave unit has the channel or right to broadcast, for varying lengths of time, and if a remote did not respond, the Master would need to time out before moving on to the next unit in the list. The maximum number of Remotes which can communicate with a Master in this configuration is 2^{13} (8192).

To configure a Standard TDMA network, the default settings described in 4.3 are applicable, with the exception that the following registers on the Master must be modified as required:

- S244 Channel Request Mode
- S251 Master Hop Allocation Timeout

For TDMA, set S244=1. (Must be set on Master and all Slaves)

The default for S251 is 10 (hop intervals). If the system is to be deployed in a 'clean' RF environment, this number should perhaps be reduced to 2 or 3 to provide enough time for the Slave to initiate its response but to not potentially waste a significant number of hop intervals waiting for an unresponsive Slave to send data.

In addition, the following AT commands (ref. Section 6.1) are used to populate, view and change the Registered Slaves List:

- T? view entire Registered Slaves List
- Tn= UA enter a Slave's Unit Address (UA) into the Registered Slave's List item number n , where $n=0-8191$, and $UA = 0-65534$ (selecting a UA value of 0 terminates the list)
- Tn? view Registered Slaves List entry number n , where $n=0-8191$. Response is UA of List entry

The default Registered Slaves list consists of 8192 entries (0-8191), populated with Unit Addresses of 2 thru 8193 respectively.

On the following page is an example to illustrate basic TDMA operation. For an actual deployment, application-specific parameters must be considered and other various modem configuration options optimized accordingly.

4.0 900 MHz Frequency Hopping Configuration

Example:

5 Slaves, configured with PMP defaults (&F2). Unit Addresses: 3, 7, 10, 15, and 21.
UA 3 has some data, 7 has no data, 10 has data, 15 is powered-off, and 21 has data but its RF connection is very intermittent due to an intermittent outdoor antenna connection.
Master has been configured as PMP default Master (&F1). Clean RF environment.

Changes to be made to the Master:

S244=1
S251=3
ATT0=3
ATT1=7
ATT2=10
ATT3=15
ATT4=21
ATT5=0 (this terminates the list)

The Master will 'poll' (give the opportunity to transmit) the Slave with UA 3. This Slave will transmit all of its data and then inform the Master of same.

On the next hop, the Master will sequence to the next modem, UA 7. Slave 7 will inform the Master it has no data and on the next hop, the Master will sequence to UA 10.

Slave 10 will transmit its data and inform the Master when complete.

The Master then polls unit 15, no response. On the next hop interval, the Master will poll unit 15 again: no response. It will poll one more time on the following hop interval and, with no response, will move on to poll UA 21 which has data and sends it to the Master—but due to the faulty outdoor antenna connection, the Master does not receive the message from the Slave indicating that it has sent all of its data, so the Master will wait for the value of S251 (3 hops) for such a message from the Slave before moving on to begin the cycle again at UA 3.

4.0 900 MHz Frequency Hopping Configuration

4.3.7 Peer-to-Peer (P2P)

P2P mode is used for communications between pairings of Remote modems,

e.g. Slave 12 can exchange data with (only) Slave 14, Slave 6 can exchange data with (only) Slave 7, etc.



A P2P network requires a Master modem.

The data being transmitted from one Slave to another in P2P mode is transferred via the Master.

There are no specific factory default settings for P2P modems.

To establish a basic P2P network:

Master

- enter into Command Mode
- load the &F1 factory default settings
- change the Network Type (S133) to 2
- change Packet Retransmissions (S113) from 5 to 0 (increase from 0 if required)
- save the change using the AT&W command
- go online with the ATA command

Slave 1

- enter into Command Mode
- load the &F2 factory default settings
- change the Network Type (S133) to 2
- change the Destination Address to 3 (to be the UA of Slave 2)
- save the change using the AT&W command
- go online with the ATA command

Slave 2

- enter into Command Mode
- load the &F2 factory default settings
- change the Network Type (S133) to 2
- change the Unit Address (S105) to 3
- change the Destination Address to 2 (the UA of Slave 1)
- save the change using the AT&W command
- go online with the ATA command

The Master will broadcast (actually 're-broadcast') the data incoming to it from both Slaves to all (2) Slaves; one Slave's data has a destination being the other Slave and vice versa.

4.0 900 MHz Frequency Hopping Configuration

4.3.8 Everyone-to-Everyone (E2E)

E2E mode is used for communications between all remote modems,

i.e. data from every modem is broadcast to every other modem in the network.

Considering the amount of data re-broadcasting (via the Master), it is a very bandwidth-intensive network topology.

There are no specific factory default settings to configure modems for E2E operation.

To establish a basic E2E network:



An E2E network requires a Master modem.

The data being transmitted from remote units in an E2E network travels to the Master and is then re-broadcast to all other remotes.

Master

- enter into Command Mode
- load the &F1 factory default settings
- change the Network Type (S133) to 2
- change Packet Retransmissions (S113) from 5 to 0 (increase from 0 if required)
- save the change using the AT&W command
- go online with the ATA command

Slaves

- enter into Command Mode
- load the &F2 factory default settings
- change the Network Type (S133) to 2
- change the Unit Address (S105) to a unique number (range: 2-65534)
- change the Destination Address to 65535 (the broadcast address)
- save the change using the AT&W command
- go online with the ATA command

5.0 400 MHz Frequency Hopping Configuration

To begin configuration, the SDR400 must be mounted into either a Microhard supplied development board (with factory attached interface card), or be mounted into a customer designed platform. The SDR400 is configured using AT commands through the **Data** port, or using special diagnostic commands through the **Diagnostic** Port. Refer to [Section 2: Hardware Description](#) for information related to inter-facing to, or powering the module.

To issue AT commands through the **Data** port, the SDR400 must first be set into **Command Mode** as de-scribed below.

5.1 Configuration/Unit Modes

5.1.1 Command Mode



400 MHz Frequency Hopping is a order option (C1S, C2S) and must be specified at the time of order and set at the factory.

- the SDR400 module is offline (data is not passing through the unit via it's local data lines or RF communications)
- if installed in a Development Board, the only LED illuminated will be the blue power LED.
- the SDR400's configuration options (registers) may be viewed and modified using AT commands.

Two methods are typically used to place the SDR400 Series into Command Mode.

1. Force to Command Mode

- Power down off the Development Board assembly.
- Connect a 9-pin straight-through serial cable from the PC serial port to the rear RS-232 port (DATA) of the modem.
- Launch a terminal communications program (e.g. HyperTerminal) and configure for 9600bps, 8 data bits, No parity, 1 stop bit (8N1), no flow control
- press and hold the CONFIG button
- continue to press the CONFIG button and apply power to the modem
- release the CONFIG button
- On power up the terminal session window should show "NO CARRIER OK" as seen below:

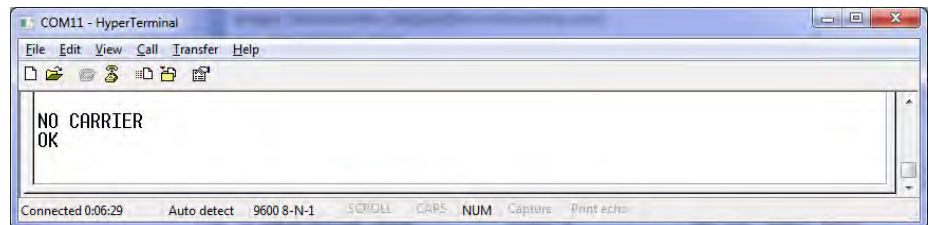

Image 5-1: Command Mode

- the SDR400 is now in command mode, and AT commands can be used to configure or query the settings. AT&V will display the current configuration, and the registers can be queried using the AT&XXX=? Command where XXX = the register number. Help is available using the AT&XXX /? Command.
- Any and all changes must be written to NVRAM using the AT&W command.

5.0 400 MHz Frequency Hopping Configuration

2. Escape from Data Mode

- With the SDR400 powered up and 'online', connect a 9-pin straight-through serial cable from the PC serial port to the RS-232 DATA port on the dev board.
- Launch a terminal program (e.g. HyperTerminal) and configure for the SDR400's established serial baud rate parameters (PC & modem must match).
- Pause 1 second, type '+++', pause 1 second: the monitor should show the module response of 'NO CARRIER OK'



400 MHz Frequency Hopping is a order option (C1S, C2S) and must be specified at the time of order and set at the factory.

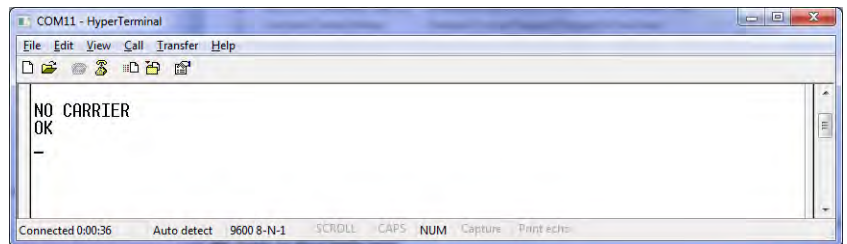

Image 5-2: Command Mode

- The SDR400 is now in command mode, and AT commands can be used to configure or query the settings.
- Entering the AT&V command as shown will show the current configuration as seen below: (The data displayed varies based on network and unit type.)

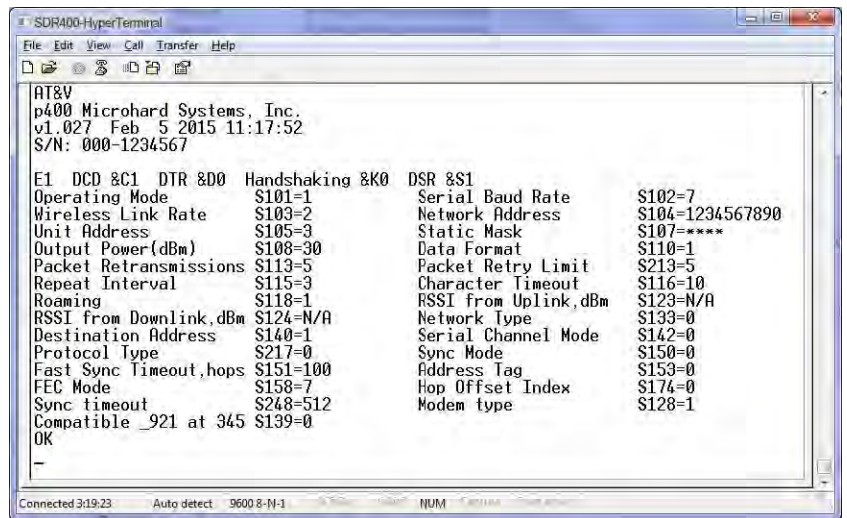

Image 5-3: Command Mode - AT&V Display

5.1.2 Data Mode

Data Mode is the normal operational state of all deployed SDR400 modules. In this mode the module is prepared to exchange data as per its configuration settings. Available LED indications can provide an indication of the data exchange (TX and RX LEDs).

To enter DATA mode from COMMAND mode, enter the command: **ATA [Enter]**

5.0 400 MHz Frequency Hopping Configuration

5.1.3 Modem Type (S128)

The SDR400 is a Multi-Frequency Modem that is capable of operating in one of three (3) different modem types. The three different modem types of the SDR400 are (1) 400 MHz Narrowband Licensed Band Mo-dem, (2) 900 MHz FHSS modem operating in the 900 MHz ISM band and (3) as a 400 MHz Frequency Hopping Modem. It is important to set the correct modem type before commencing with any additional configuration parameters.

This section describes the configuration of a modem that has been set to operate as a 400 MHz Fre-quency Hopping, operating in the 410 to 480 MHz Frequency Band. The SDR400 in 400 MHz mode is **not** compatible with MHX425 and n425 radios from Microhard Systems.

The modem type can be selected using the register S128 (Modem Type) as follows:

Modem Type **S128** = 0 - 400 MHz Narrow Band (NB) Modem
= 1 - 900 MHz Frequency Hopping (FH) Modem
= **2 - 400 MHz Frequency Hopping (FH) Modem***

*** 400 MHz FHSS is an order option (-C2S or -C1S) and must be speci-fied at time of order and enabled at the factory before being shipped.**

The following image shows the current options for the modem type as described above.



Registers can be changed by entering the AT command as seen below:

Example:
ATS128=2 <enter>

Any registers that are changed must be written to flash using the **AT&W** command>

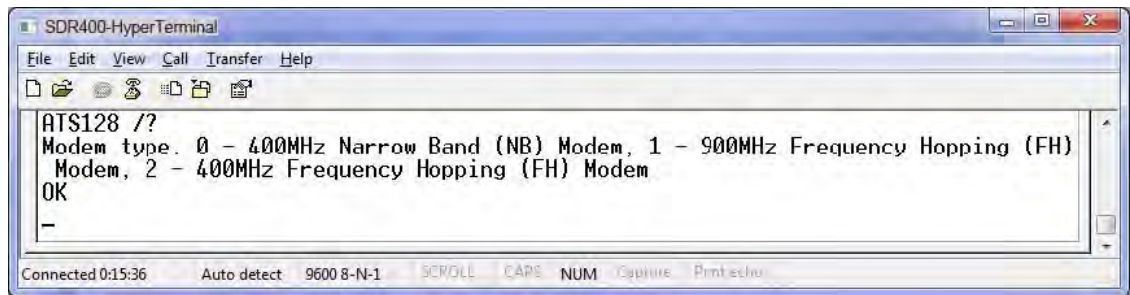

Image 5-4: Modem Type S128

5.1.4 Network Type (S133)

Once configured to operate as a 400 MHz Frequency Hopping (FH) modem, the Network Type must be decided and planned for a successful deployment. The SDR400 currently supports Point to Point, Point to Multipoint network topologies.

To change the network type the register S133 (Network Type) is used as seen below:

Network Type **S133** = **0 - Point to Multipoint**
= 1 - Point to Point
= 2 - Peer to Peer
= (Additional Modes may be available)

Ensure the correct network type is set before proceeding. It is recommended to start with the factory default settings to aid in initial configuration (discussed later), and then changing registers as required.



400 MHz Frequency Hopping is an order option (C1S, C2S) and must be specified at the time of order and set at the factory.

5.0 400 MHz Frequency Hopping Configuration

5.1.5 Hopping On Frequency Table

The SDR400 set to 400 MHz Frequency Hopping gives the customer an ability to define a frequency hopping table which is suitable for their applications. Network address and encryption key still play important roles for synchronization and network separation. This section describes AT commands and registers related to hopping on frequency table.

Hopping mode register (S238) is preset by the manufacturer. It is a read-only register for the end user. S238 controls the modem either hopping on pattern or on frequency table. AT+S238? AT command can be used to display current value of this register.

0	Hopping on pattern
*1	Hopping on frequency table

Note that this is not shown in the register list when AT+V command is issued.

5.1.5.1 Frequency Tables

Frequency tables are a list of frequencies used by the modem to communicate with each other. The modem hops onto one frequency and communicates for a certain amount of time, then hops to the next one in the list.

There are two frequency tables: the primary frequency table and the secondary frequency table. The primary table is used between the master and its direct slaves or repeaters; the secondary table is used for the repeater to communication with its slaves.

Only the primary table needs to be defined on the master and a slave; both primary and secondary table need to be defined on a repeater.

5.1.5.2 ATP0 and ATP1 Commands

The command ATP0 is used to create/modify the primary frequency table, ATP1 is for the secondary frequency table. Since these two commands have the same syntax, the following will use ATP0 as an example. **Both tables (ATP0 & ATP1) must be populated before the modem will go online.**

Editing Frequency Table

ATP0= command allows a user to edit the frequency table channel by channel. The user can press ESC to exit from editing mode. Any valid frequencies typed will be saved into the table automatically.

A valid input format is as follows,

####.#####

The value given here is in MHz.

The BACKSPACE key can be used to correct mistakes when typing a frequency. Once ENTER is pressed, the value will be accepted if it has the right format. An accepted value can NOT be modified with the BACKSPACE key. If changing is desired, the table has to be entered.



400 MHz Frequency Hopping is a order option (C1S, C2S) and must be specified at the time of order and set at the factory.

5.0 400 MHz Frequency Hopping Configuration

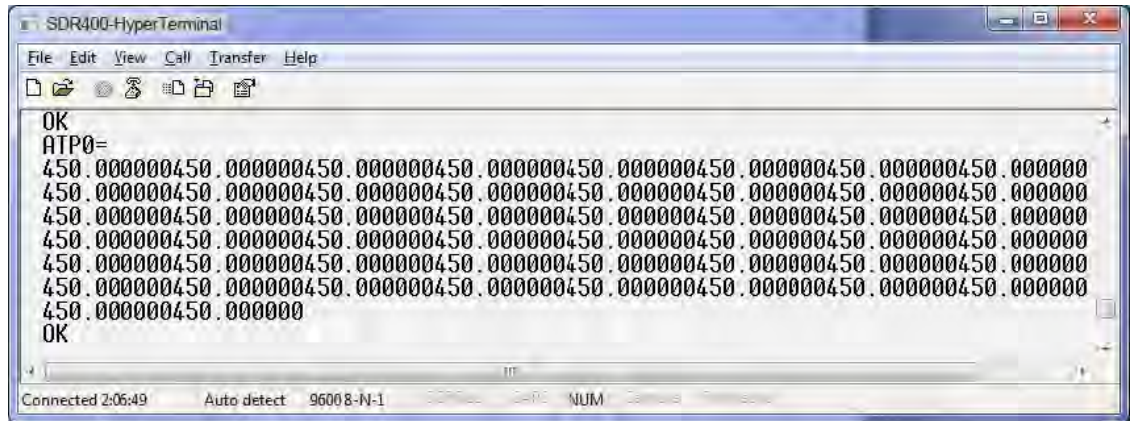

Image 5-6: Frequency Table: Manual Entry



400 MHz Frequency Hopping is a order option (C1S, C2S) and must be specified at the time of order and set at the factory.

A better way to load a frequency table is using “Send Text File...” from HyperTerminal after the ATP0=<enter> command is issued from command mode. The text file should be prepared so that it has one frequency per line. Each line should end with CR (Carriage Return) and LF. The file should look like this, for example:

```
420.000000
422.000000
424.000000
426.750000
430.000000
435.000000
440.000000
450.000000
470.000000
410.000000
420.000000
422.000000
424.000000
426.750000
430.000000
435.000000
440.000000
450.000000
470.000000
410.000000
```

... ..

Duplicated frequency can exist in the frequency table, but all 50 channels must be populated.,

5.0 400 MHz Frequency Hopping Configuration

Displaying Frequency Table

ATP0? Displays the current frequency table all at once. There are 50 channels in the frequency table.



400 MHz Frequency Hopping is a order option (C1S, C2S) and must be specified at the time of order and set at the factory.

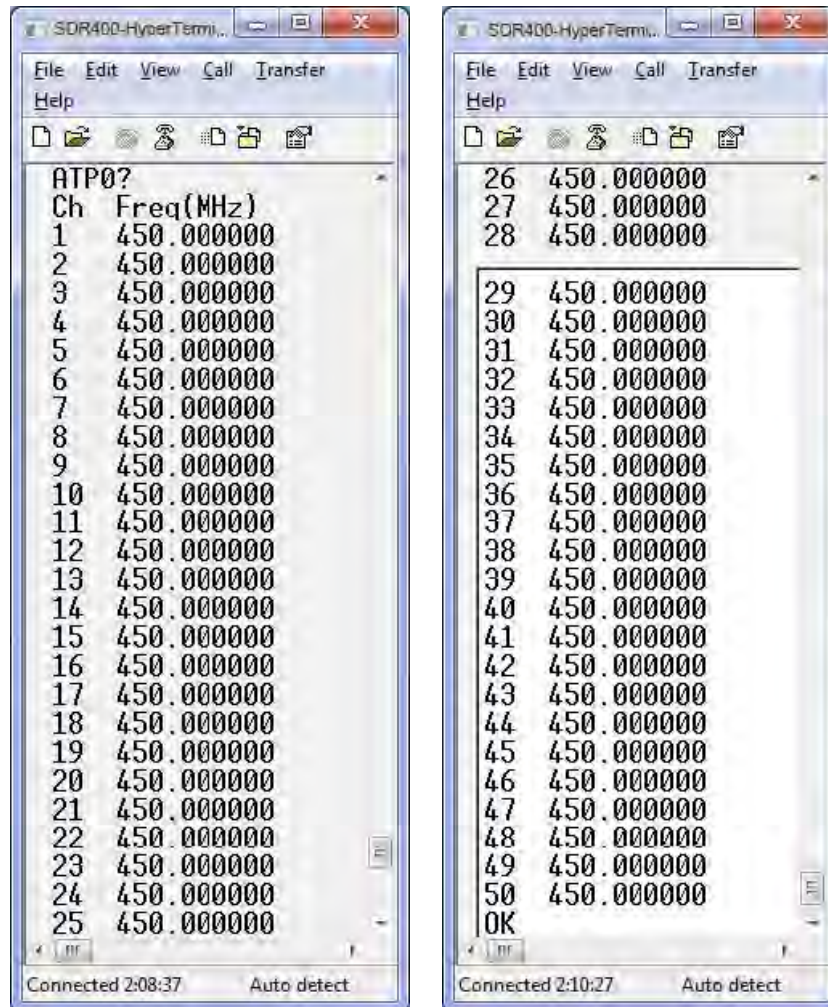

Ch	Freq(MHz)
1	450.000000
2	450.000000
3	450.000000
4	450.000000
5	450.000000
6	450.000000
7	450.000000
8	450.000000
9	450.000000
10	450.000000
11	450.000000
12	450.000000
13	450.000000
14	450.000000
15	450.000000
16	450.000000
17	450.000000
18	450.000000
19	450.000000
20	450.000000
21	450.000000
22	450.000000
23	450.000000
24	450.000000
25	450.000000
26	450.000000
27	450.000000
28	450.000000
29	450.000000
30	450.000000
31	450.000000
32	450.000000
33	450.000000
34	450.000000
35	450.000000
36	450.000000
37	450.000000
38	450.000000
39	450.000000
40	450.000000
41	450.000000
42	450.000000
43	450.000000
44	450.000000
45	450.000000
46	450.000000
47	450.000000
48	450.000000
49	450.000000
50	450.000000

Image 5-6: Frequency Tables (ATP0, ATP1)

5.0 400 MHz Frequency Hopping Configuration

5.2 Point to Point Network

In a point-to-point network, a path is created to transfer data between Point A and Point B, where Point A may be considered the Master modem and Point B a Slave. Such a PTP network may also involve one or more Repeaters (in a store-and-forward capacity) should the radio signal path dictate such a requirement. Point to Point is enabled by setting register S133 to 1 (*ATS133=1, Network Type*).

A PTP configuration may also be used in a more dynamic sense: there may be many Slaves (and Repeaters) within such a network, however the Master may have its 'Destination Address' (S140) changed when required to communicate with a specific Slave.



400 MHz Frequency Hopping is a order option (C1S, C2S) and must be specified at the time of order and set at the factory.

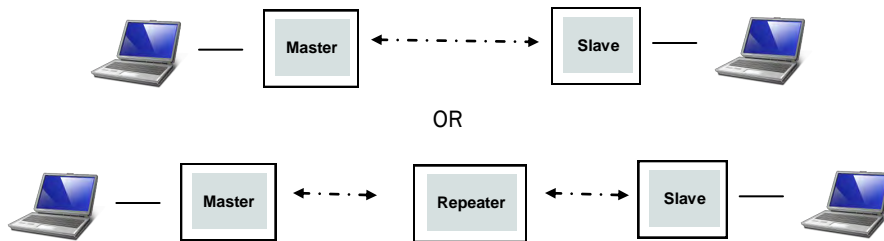

Drawing 5-1: Point to Point Network Topology

5.2.1 Operating Modes / Unit Types

In a Microhard Point to Point Network, three unit types or operating modes are available: the Master, Repeater, and the Remote. The **Masters** role is to provide network synchronization for the system, which ensures all units are active and able to communicate as required. The Master controls the flow of data through the system; all data passes through it. The diagram below shows a unit configured as a Master.

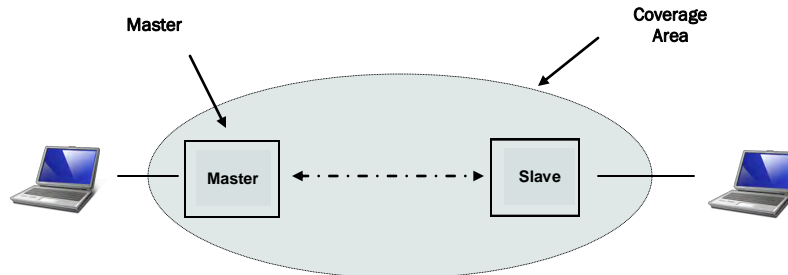

Drawing 5-2: Point to Point Master

5.0 400 MHz Frequency Hopping Configuration

Repeaters can be used to extend the coverage of the Master. Required only if necessary to establish a radio path between a Master and Slave(s); stores and forwards data sent to it. Synchronizes to Master and provides synchronization to 'downstream' units. If a local device is attached to a Repeater's serial data port, the Repeater will also behave as a Slave (aka Repeater/Slave).

Adding one or more Repeaters within a network will cut the overall throughput of the network in **half**; the throughput is halved only once, i.e. it does not decrease with the addition of more Repeaters. If there is a 'path' requirement to provide Repeater functionality, but throughput is critical, a work around is to place two modems at the Repeater site in a 'back-to-back' configuration. One modem would be configured as a Slave in the 'upstream' network; the other a Master (or Slave) in the 'downstream' network. Local connection between the modems would be a 'null modem' cable. Each modem would require its own antenna; careful consideration should be given with respect to antenna placement and modem configuration.



400 MHz Frequency Hopping is an order option (C1S, C2S) and must be specified at the time of order and set at the factory.

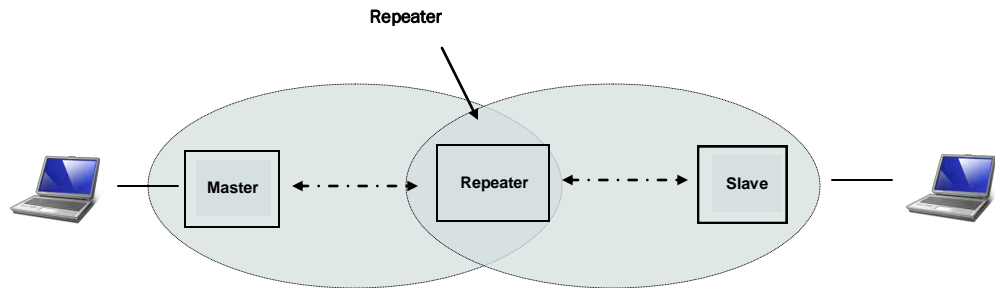

Drawing 5-3: Point to Point Repeater

A **Slave (Remote)** is an endpoint/node within a network to which a local device is attached. Communicates with Master either directly or through one or more Repeaters.

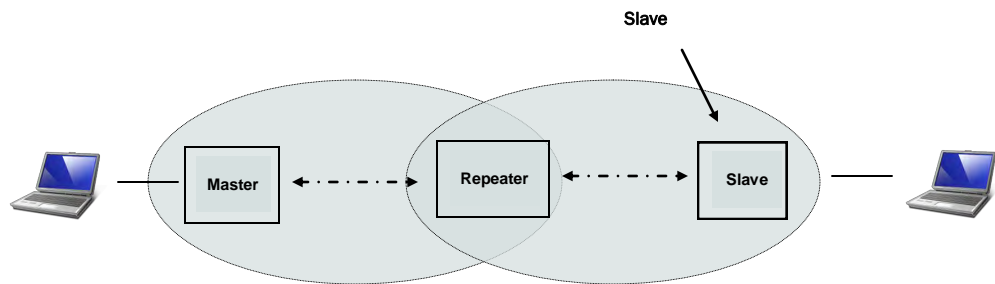

Drawing 5-4: Point to Point Slave

Units can be configured to perform the various roles discussed by setting register S101 as follows:

- ATS101 = 0 - Master
- ATS101 = 1 - Repeater
- ATS101 = 2 - Slave (Remote)

5.0 400 MHz Frequency Hopping Configuration

5.2.2 Configuration Using Factory Defaults

Factory default setting commands can be used to aid in the configuration and deployment of the SDR400 modules, providing a known starting point in the configuration process for each unit type. Using the factory default commands sets all applicable registers to factory recommended settings and allows for initial connectivity between units. Configuring modems using the factory default settings have the following benefits:

- hastens the configuration process - *load default settings and, if necessary, apply only minor settings / adjustments*
- aids in troubleshooting - *if settings have been adjusted and basic communications cannot be established, simply revert to the factory default setting and any improper adjustments will be overwritten and a 'fresh start' can be made with known-to-work settings*



400 MHz Frequency Hopping is an order option (C1S, C2S) and must be specified at the time of order and set at the factory.

For many networks, the factory default commands may be all that is necessary to configure and deploy a simple Point to Point Network. Other applications may require additional registers to be configured. Regardless of the complexity of the configuration, the factory default settings provide a starting point for all configurations. All unit types have a factory default setting command.

AT&F6 + ATS128=2	-	Point to Point Master (Fast - 172kbps)
AT&F7 + ATS128=2	-	Point to Point Slave (Fast)
AT&F8 + ATS128=2	-	Point to Point Master (Slow - 19.2kbps)
AT&F9 + ATS128=2	-	Point to Point Slave (Slow)

For 400 MHz Hopping Modems, the Modem type (ATS128=2) must be changed after the AT&F command has been executed. The screen shots for each unit type highlight the key registers that are automatically changed to create a Point to Point configuration. There may also be additional registers such as the Network ID that are recommended to be changed.



Each PTP Network must have a unique network ID. This can be changed using register S104: Network Address.

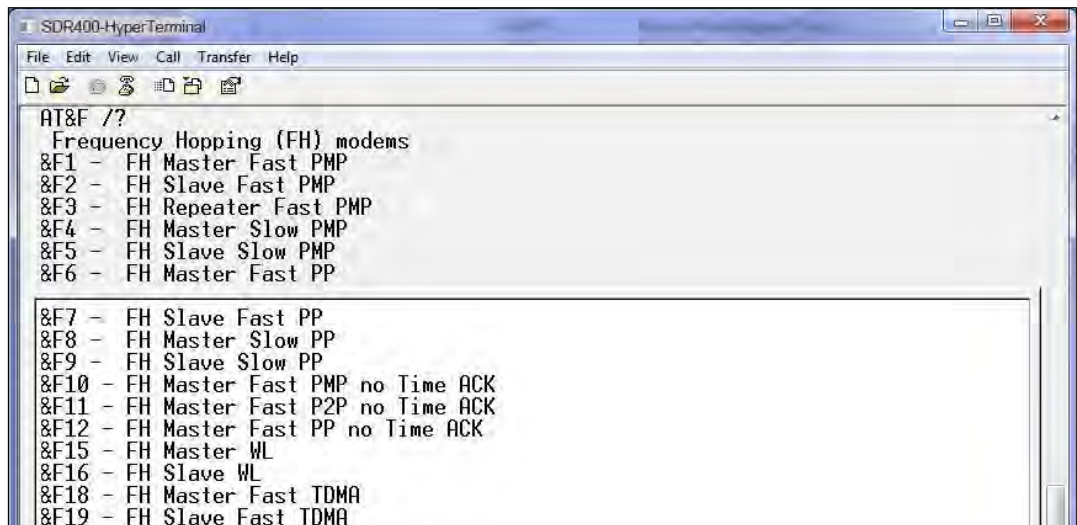

Image 5-5: Factory Defaults

5.0 400 MHz Frequency Hopping Configuration

AT&F6 Point to Point Master (Fast)

```

SDR400-HyperTerminal
File Edit View Call Transfer Help
[Icons]
AT&F6 A
OK
ATS128=2 B
OK
AT&W C
OK
AT&V D
p400 Microhard Systems, Inc.
v1.027 Debug Feb 9 2015 08:24:59
S/N: 000-1234567

E1 DCD &C1 DTR &D0 Handshaking &K0 DSR &S1
Operating Mode S101=0 G
Wireless Link Rate S103=2 H
Unit Address E S105=1
Output Power(dBm) S108=30
Packet Retransmissions S113=5
Character Timeout S116=10
RSSI from Downlink, dBm S124=N/A
Destination Address S140=2 F
Serial Channel Mode S142=0
Sync Mode S150=0
Address Tag S153=0
FEC Mode S158=7
RSSI Min Uplink, dBm S223=-0
OK
Serial Baud Rate J S102=7
Network Address K S104=1234567890
Static Mask S107=****
Data Format S110=1
Packet Retry Limit S213=5
RSSI from Uplink, dBm S123=N/A
Network Type S133=1 I
Repeaters Y/N L S141=0
Protocol Type S217=0
Fast Sync Timeout, hops S151=100
Multimaster Mode S154=0
Modem type S128=2
RSSI Max Uplink, dBm S224=N/A
    
```



400 MHz Frequency Hopping is a order option (C1S, C2S) and must be specified at the time of order and set at the factory.



Both frequency tables (ATP0 & ATP1) must be populated before changes can be saved & modem can be brought online.

Image 5-6: Factory Defaults AT&F6 - Point to Point Master

- A) AT&F6 - Sets the factory defaults for a Point to Point Master.
- B) S128 - Must be set to 2 (ATS128=2) for 400 MHz Frequency Hopping Operation.
- C) AT&W - Writes the changes to NVRAM.
- D) AT&V - Displays the configuration as seen above.
- E) S105 - Every unit in a Point to Point Network must have a unique unit address. The Master is automatically set to 1, and should not be changed.
- F) S140 - The destination address is unit address of the final destination, which all data is to be sent. The address entered would generally be the unit address of the Slave.
- G) S101 - The operating mode defines the unit type and is set to 0, which is a Master.
- H) S103 - Wireless Link Rate must be set to the same value of each unit in the system. Higher link rates may result in higher throughput, but lower link rates usually provide better sensitivity and overall robustness.
- I) S133 - The network type must be set to 1 for Point to Point operation. The content displayed by the AT&V command will vary with the network type.
- J) S102 - The serial baud rate (and data format S110) must match that of the connected device.
- K) S104 - Each unit in a Network must have the same Network Address. It is strongly recommended to never use the default setting of 1234567890. To change the Network Address, the ATS104=XXXXXXX command can be used.
- L) S141 - This register informs the master if 1 or more repeaters are present in the system. This applies only to the master radio.

Remember, anytime registers are changed the values must be written to NVRAM using the AT&W command. To switch from command mode to data mode (online mode), the ATA command can be issued.

5.0 400 MHz Frequency Hopping Configuration

AT&F7 Point to Point Slave (Fast)

```

SDR400-HyperTerminal
File Edit View Call Transfer Help
[Icons]
AT&F7 A
OK
AT$128=2 B
OK
AT&W C
OK
AT&V D
p400 Microhard Systems, Inc.
v1.027 Debug Feb 9 2015 08:24:59
S/N: 000-1234567

E1 DCD &C1 DTR &D0 Handshaking &K0 DSR &S1
Operating Mode S101=2 G
Wireless Link Rate S103=2 H
Unit Address E S105=2
Output Power(dBm) S108=30
Packet Retransmissions S113=5
Repeat Interval S115=3
Roaming L S118=1
RSSI from Downlink,dBm S124=N/A
Destination Address F S140=1
Protocol Type S217=0
Fast Sync Timeout,hops S151=100
FEC Mode S158=7
Modem type S128=2
RSSI Max Uplink,dBm S224=N/A
OK

Serial Baud Rate J S102=7
Network Address K S104=1234567890
Static Mask S107=****
Data Format S110=1
Packet Retry Limit S213=5
Character Timeout S116=10
RSSI from Uplink,dBm S123=N/A
Network Type I S133=1
Serial Channel Mode S142=0
Sync Mode S150=0
Address Tag S153=0
Sync timeout S248=512
RSSI Min Uplink,dBm S223=-0
    
```



400 MHz Frequency Hopping is a order option (C1S, C2S) and must be specified at the time of order and set at the factory.



Both frequency tables (ATP0 & ATP1) must be populated before changes can be saved & modem can be brought online.

Image 5-7: Factory Defaults AT&F7 - Point to Point Slave

- A) AT&F7 - Sets the factory defaults for a Point to Point Slave.
- B) S128 - Must be set to 2 (ATS128=2)for 400 MHz Frequency Hopping Operation.
- C) AT&W - Writes the changes to NVRAM.
- D) AT&V - Displays the configuration as seen above.
- E) S105 - Every unit in a Point to Point Network must have a unique unit address. The address of the slave (remote) is automatically set to 2. *This can be changed, but ensure that the destination address on the master is also changed!*
- F) S140 - The destination address is unit address of the final destination to which all data is to be sent. In a Point to Point Network this address is set to 1, the unit address of the master, and should not be changed.
- G) S101 - The operating mode defines the unit type and is set to 2, which is a Slave (Remote).
- H) S103 - Wireless Link Rate must be set to the same value of each unit in the system.
- I) S133 - The network type must be set to 1 for Point to Point operation. The content displayed by the AT&V command varies with the network type.
- J) S102 - The serial baud rate (and data format S110) must match that of the connected device.
- K) S104 - Each unit in a Network must have the same Network Address. To change the Network Address, the ATS104=XXXXXXX command can be used.
- L) S118 - If the slave is to connect through a repeater, enter the unit address of the repeater here.

5.0 400 MHz Frequency Hopping Configuration

Point to Point Repeater

There is no Factory default mode for a PTP Repeater, the procedure below outlines the steps required to add a repeater to a PTP system.

Note that the Master has a register 'S141 - Repeaters Y/N' and the Slave does not. This register informs the Master of there being one or more Repeaters in this network. The factory defaults assume 'no' and assign a value of 0. If a Repeater is to be installed, and all the Master and Slave defaults will be maintained, following is a procedure on how to configure a Repeater into this fixed (non-mobile) PTP network: (If AT&F commands where used, also ensure ATS128=2 (modem type for 400 MHz frequency hopping)).

Master

- enter into Command Mode
- change S141 (Repeaters Y/N) to 1 (which means 'Yes')
- save the change using the AT&W command
- go online with the ATA command

Repeater

- enter into Command Mode
- load a third modem with AT&F7 and ATS128=2 (PTP Slave factory default settings)
- change the Operating Mode (S101) from 2 (Slave) to 1 (Repeater)
- change the Unit Address (UA) (S105) from 2 to 3
- save the changes using the AT&W command
- go online with the ATA command

Slave

- enter into Command Mode
- change S118 from 1 (the UA of the Master) to 3 (the UA of the Repeater)
- save the change using the AT&W command
- go online with the ATA command

This system may be tested by sending text at 9600bps, 8N1 through the RS-232 serial port of one modem and observing that it appears at the RS-232 serial port of the other modem. The Slave is synchronized to the Repeater, which in turn is synchronized to the Master. If the Repeater is taken offline, in a matter of moments the Slave's RSSI LEDs will indicate that it is 'scanning' for its immediate upstream unit; place the Repeater online and the Slave will quickly acquire it. If the Master is taken offline, both the Repeater and Slave will begin to scan.



400 MHz Frequency Hopping is a order option (C1S, C2S) and must be specified at the time of order and set at the factory.

5.0 400 MHz Frequency Hopping Configuration

5.2.3 Retransmissions

Packet Retransmissions can be used to ensure data reaches its intended destination by resending the same packet over and over. In Point to Point system all data is acknowledged by the destination, resulting in retransmissions only being used if no acknowledgement is received. The overall impact on system performance, while not as significant as it is in Mesh and Point to Multipoint networks, should still be considered. The more times a modem retransmits data, the more the overall throughput of the system is reduced. To adjust the retransmission rate, use register S113, the default value is 5 (+ the initial transmission).

S113 = 5 - Packet Retransmissions (0-254)

Retransmissions are typically used in noisy environments to combat interference and low signal strength, ensuring data is received at the intended destination.



400 MHz Frequency Hopping is a order option (C1S, C2S) and must be specified at the time of order and set at the factory.

5.2.4 Network Synchronization

Network Synchronization is what allows all units to hop from frequency to frequency at the same time. For units to synchronize with the network, each unit must have the same:

- Network ID (S104)
- Network Type (S133)

Sync Timeout

Once synchronized to the network the unit does not need to receive sync data often to keep track of where the system is supposed to be (in time and frequency). The sync Timeout defines the number of hops where no sync data is received from a Master and/or Repeater before losing sync. In other words, how long a unit will remain synchronized with the network without receiving any sync packets before it gives up and loses sync.

S248 = 512 Sync Timeout (4-65534)

Setting a value too low will cause the unit to lose sync easily and time will be wasted trying to re-sync to the network. Several hops can go by without receiving a sync packet, and this is completely normal. If this value is set too high, the unit will assume for a long time that the network is still out there, when especially in mobile applications, it may not be.

5.0 400 MHz Frequency Hopping Configuration

5.3 Point to Multipoint Network

In a Point to Multipoint Network, a path is created to transfer data between the Master modem and numerous remote modems. The remote modems may simply be Slaves with which the Master communicates directly, and/or Slaves which communicate via Repeaters. Some or all of the Repeaters may also act as Slaves in this type of Network, i.e. the Repeaters are not only storing and forwarding data, but are also acting as Slaves. Such Repeaters may be referred to as 'Repeater/Slaves'. Point to Multipoint is enabled by setting register S133 to 0 (*ATS133=0, Network Type*).



400 MHz Frequency Hopping is an order option (C1S, C2S) and must be specified at the time of order and set at the factory.

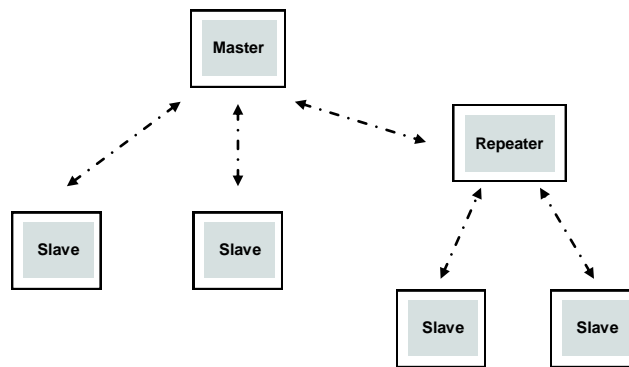

Drawing 5-1: Point to Multipoint Network Topology

5.3.1 Operating Modes / Unit Types

In a Microhard Point to Multipoint Network, three unit types or operating modes are available: the Master, the Repeater, and the Remote. The **Master** modems role is to provide network synchronization for the system, which ensures all units are active and able to communicate as required. The Master controls the flow of data through the system; all data passes through it. The diagram below shows a unit configured as a Master.

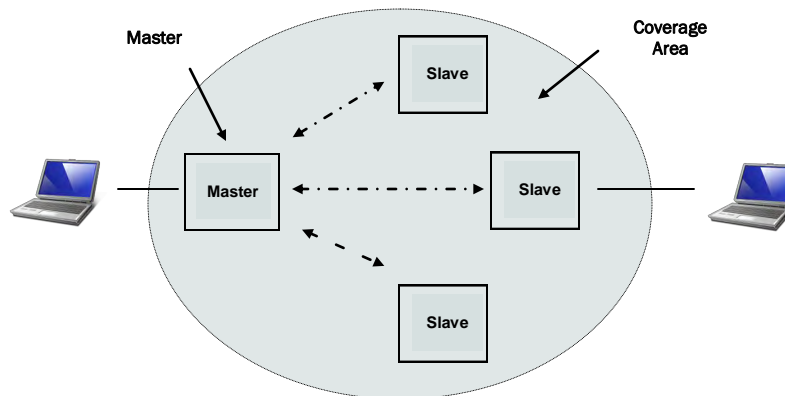

Drawing 5-2: Point to Multipoint Master

5.0 400 MHz Frequency Hopping Configuration

Repeaters can be used to extend the coverage of the Master. Required only if necessary to establish a radio path between a Master and Slave(s); stores and forwards data sent to it. Synchronizes to Master and provides synchronization to 'downstream' units. If a local device is attached to a Repeater's serial data port, the Repeater will also behave as a Slave (aka Repeater/Slave).

Adding one or more Repeaters within a network will cut the overall throughput of the network in **half**; the throughput is halved only once, i.e. it does not decrease with the addition of more Repeaters. If there is a 'path' requirement to provide Repeater functionality, but throughput is critical, a work around is to place two modems at the Repeater site in a 'back-to-back' configuration. One modem would be configured as a Slave in the 'upstream' network; the other a Master (or Slave) in the 'downstream' network. Local connection between the modems would be a 'null modem' cable. Each modem would require its own antenna; careful consideration should be given with respect to antenna placement and modem configuration.



400 MHz Frequency Hopping is an order option (C1S, C2S) and must be specified at the time of order and set at the factory.

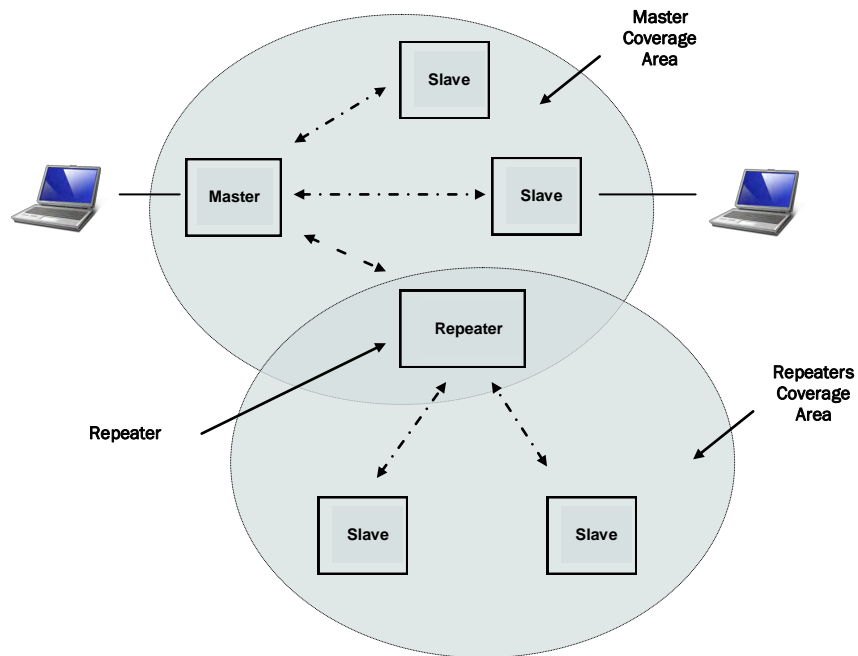

Drawing 5-3: Point to Multipoint Repeater

5.0 400 MHz Frequency Hopping Configuration

A **Slave (Remote)** is an endpoint or node within a network to which a local serial device is attached. Communicates with Master either directly or through one or more Repeaters.



400 MHz Frequency Hopping is an order option (C1S, C2S) and must be specified at the time of order and set at the factory.

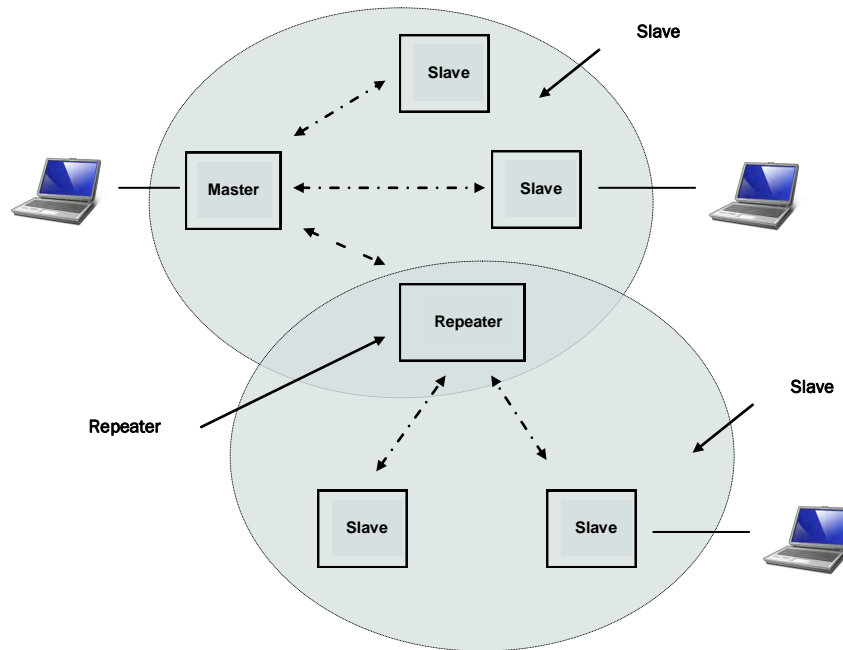

Drawing 5-4: Point to Multipoint Slave

Units can be configured to perform the various roles discussed by setting register S101 as follows:

- ATS101 = 0 - Master
- ATS101 = 1 - Repeater
- ATS101 = 2 - Slave (Remote)

The next section discussed using Factory Default commands to configure the various types of units that are available in a Point to Multipoint network, simplifying the configuration process.

5.0 400 MHz Frequency Hopping Configuration

5.3.2 Configuration Using Factory Defaults

Factory default setting commands can be used to aid in the configuration and deployment of the SDR400 series modules, providing a known starting point in the configuration process for each unit type. Using the factory default commands sets all applicable registers to factory recommended settings and allows initial connectivity between units. Configuring modems using the factory default settings have the following benefits:

- hastens the configuration process - *load default settings and, if necessary, apply only minor settings / adjustments*
- aids in troubleshooting - *if settings have been adjusted and basic communications cannot be established, simply revert to the applicable factory default setting and any improper adjustments will be overwritten and a 'fresh start' can be made with known-to-work settings*



400 MHz Frequency Hopping is an order option (C1S, C2S) and must be specified at the time of order and set at the factory.

For many networks, the factory default commands may be all that is necessary to configure and deploy a simple Point to Multipoint Network. Other applications may require additional registers to be configured. Regardless of the complexity of the configuration, the factory default settings provide a starting point for all configurations. All PMP unit types have a factory default setting command.

AT&F1 + ATS128=2	-	Point to Multipoint Master (Fast - 172kbps)
AT&F2 + ATS128=2	-	Point to Multipoint Slave
AT&F3 + ATS128=2	-	Point to Multipoint Repeater
AT&F4 + ATS128=2	-	Point to Multipoint Master (Slow Mode - 19.2kbps)
AT&F5 + ATS128=2	-	Point to Multipoint Slave

For 400 MHz Hopping Modems, the Modem type (ATS128=2) must be changed after the AT&F command has been executed. The screen shots for each unit type will highlight the key registers that are automatically changed to create a Point to Multipoint configuration. There may also be additional registers such as the Network ID that are recommended to be changed.



Each PMP Network must have a unique network ID. This can be changed using register S104: Network Address.

```

SDR400-HyperTerminal
File Edit View Call Transfer Help
AT&F ??
Frequency Hopping (FH) modems
&F1 - FH Master Fast PMP
&F2 - FH Slave Fast PMP
&F3 - FH Repeater Fast PMP
&F4 - FH Master Slow PMP
&F5 - FH Slave Slow PMP
&F6 - FH Master Fast PP
&F7 - FH Slave Fast PP
&F8 - FH Master Slow PP
&F9 - FH Slave Slow PP
&F10 - FH Master Fast PMP no Time ACK
&F11 - FH Master Fast P2P no Time ACK
&F12 - FH Master Fast PP no Time ACK
&F15 - FH Master WL
&F16 - FH Slave WL
&F18 - FH Master Fast TDMA
&F19 - FH Slave Fast TDMA
    
```

Image 5-4: Frequency Hopping Factory Defaults

5.0 400 MHz Frequency Hopping Configuration

AT&F1 Point to Multipoint Master (Fast)

```

SDR400-HyperTerminal
File Edit View Call Transfer Help
[Icons]
AT&F1 A
OK
ATS128=2 B
OK
AT&W C
OK
AT&V D
p400 Microhard Systems, Inc.
v1.027 Debug Feb 9 2015 08:24:59
S/N: 000-1234567

E1 DCD &C1 DTR &D0 Handshaking &K0 DSR &S1
Operating Mode S101=0 G Serial Baud Rate J S102=7
Wireless Link Rate S103=2 H Network Address K S104=1234567890
Unit Address E S105=1 Static Mask S107=****
Output Power(dBm) S108=30 Data Format S110=1
Packet Retransmissions S113=5 Packet Retry Limit S213=5
Character Timeout S116=10 RSSI from Uplink,dBm S123=N/A
RSSI from Downlink,dBm S124=N/A Network Type L S133=0
Destination Address F S140=65535 Repeaters Y/N M S141=0
Serial Channel Mode S142=0 Protocol Type S217=0
Sync Mode S150=0 Fast Sync Timeout,hops S151=100
Address Tag S153=0 Multimaster Mode S154=0
FEC Mode S158=7 Modem type S128=2
RSSI Min Uplink,dBm S223=-0 RSSI Max Uplink,dBm S224=N/A
OK
Connected 0:47:55 Auto detect 9600 8-N-1 NUM
  
```



400 MHz Frequency Hopping is a order option (C1S, C2S) and must be specified at the time of order and set at the factory.



Both frequency tables (ATP0 & ATP1) must be populated before changes can be saved & modem can be brought online.

Image 5-5: Factory Defaults AT&F1 - Point to Multipoint Master

- A) AT&F1 - Sets the factory defaults for a Point to Multipoint Master.
- B) S128 - Must be set to 2 (ATS128=2) for 400 MHz Frequency Hopping Operation.
- C) AT&W - Writes the changes to NVRAM.
- D) AT&V - Displays the configuration as seen above.
- E) S105 - Every unit in a Point to Multipoint Network must have a unique unit address. The Master is automatically set to 1, and should not be changed.
- F) S140 - The destination address for a PMP Network, by default is 65535, which means data is broadcast from the Master to all other units.
- G) S101 - The operating mode defines the unit type and is set to 0, which is a Master.
- H) S103 - Wireless Link Rate must be set to the same value of each unit in the system. Higher link rates may result in higher throughput, but lower link rates usually provide better sensitivity and overall robustness.
- I) S133 - The network type must be set to 0 for Point to Multipoint operation. The content displayed by the AT&V command will vary with the network type.
- J) S102 - The serial baud rate (and data format S110) must match that of the connected device.
- K) S104 - Each unit in a Network must have the same Network Address. It is strongly recommended to never use the default setting of 1234567890. To change the Network Address, the ATS104=XXXXXXX command can be used.
- L) S141 - This register informs the master if 1 or more repeaters are present in the system. This applies only to the master radio.

Remember, anytime registers are changed the values must be written to NVRAM using the AT&W command. To switch from command mode to data mode (online mode), the ATA command can be issued.

5.0 400 MHz Frequency Hopping Configuration

AT&F2 Point to Multipoint Slave (Fast)

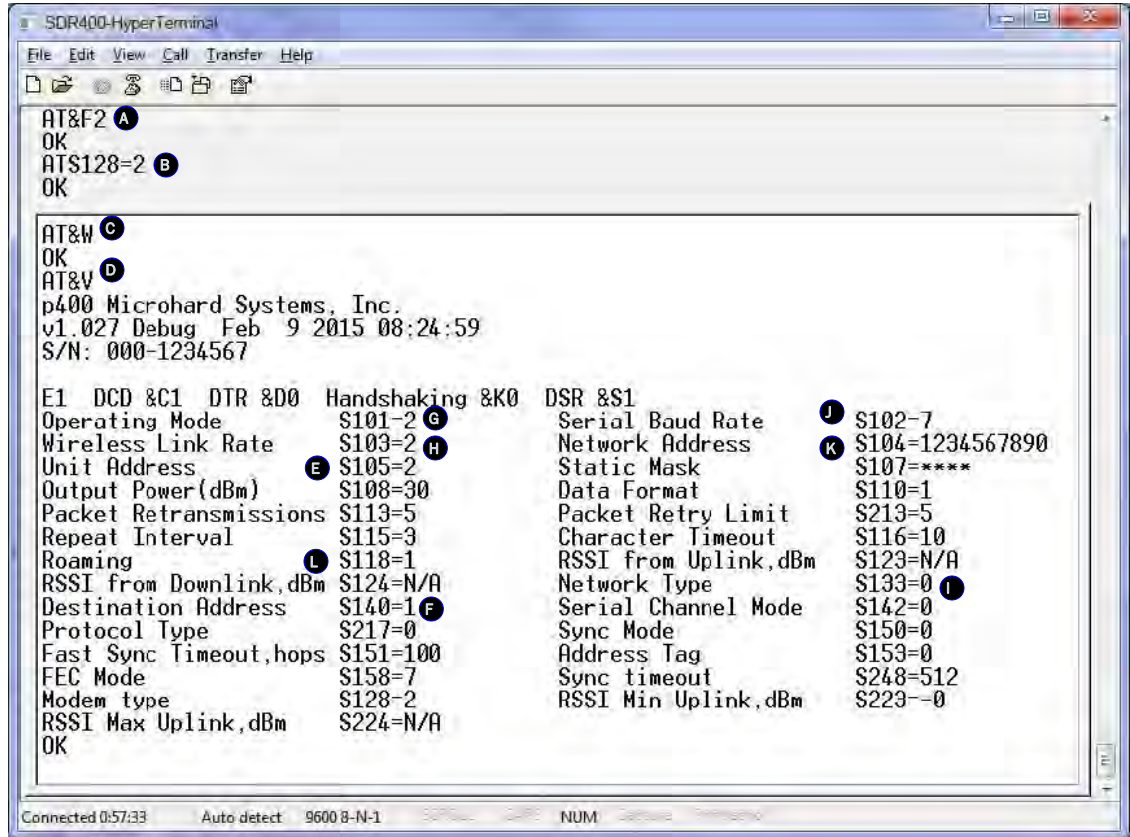

400 MHz Frequency Hopping is a order option (C1S, C2S) and must be specified at the time of order and set at the factory.



Both frequency tables (ATP0 & ATP1) must be populated before changes can be saved & modem can be brought online.

Image 5-6: Factory Defaults AT&F2 - Point to Multipoint Slave

- A) AT&F2 - Sets the factory defaults for a Point to Multipoint Slave.
- B) S128 - Must be set to 2 (ATS128=2) for 400 MHz Frequency Hopping Operation.
- C) AT&W - Writes the changes to NVRAM.
- D) AT&V - Displays the configuration as seen above.
- E) S105 - Every unit in a Point to Multipoint Network must have a unique unit address. The address of the slave (remote) is automatically set to 2. If adding more than 1 Slave, this will need to be modified for each unit added.
- F) S140 - The destination address is the final destination to which all data is to be sent. In a Point to Multipoint Network this address is set to 1, the unit address of the Master, and should not be changed.
- G) S101 - The operating mode defines the unit type and is set to 2, which is a Slave (Remote).
- H) S103 - Wireless Link Rate must be set to the same value of each unit in the system.
- I) S133 - The network type must be set to 0 for Point to Multipoint operation.
- J) S102 - The serial baud rate (and data format S110) must match that of the connected device.
- K) S104 - Each unit in a Network must have the same Network Address. To change the Network Address, the ATS104=XXXXXXX command can be used.
- L) S118 - If the slave is to connect through a repeater, enter the unit address of the repeater here.

5.0 400 MHz Frequency Hopping Configuration

AT&F3 Point to Multipoint Repeater (Fast)

```

P400 - HyperTerminal
File Edit View Call Transfer Help
AT&F3 (A)
OK
AT$128=2 (B)
OK
AT&W (C)
OK
AT&V (D)
p400 Microhard Systems, Inc.
v1.027 Debug Feb 9 2015 08:24:59
S/N: 000-1234567
E1 DCD &C1 DTR &D0 Handshaking &K0 DSR &S1
Operating Mode S101=1 Serial Baud Rate J S102=7
Wireless Link Rate S103=2 H S104=1234567890
Unit Address E S105=3 Static Mask K S107=****
Output Power(dBm) S108=30 Data Format S110=1
Packet Retransmissions S113=5 Packet Retry Limit S213=5
Repeat Interval S115=3 Character Timeout S116=10
Roaming L S118=1 RSSI from Uplink,dBm S123=N/A
RSSI from Downlink,dBm S124=N/A Network Type I S133=0
Destination Address F S140=1 Serial Channel Mode S142=0
Protocol Type S217=0 Sync Mode S150=0
Fast Sync Timeout,hops S151=100 Address Tag S153=0
FEC Mode S158=7 Hop Offset Index S174=0
Sync timeout S248=512 Modem type S128=2
RSSI Min Uplink,dBm S223=-0 RSSI Max Uplink,dBm S224=N/A
OK
Connected 1:01:18 Auto detect 9600 8-N-1 NUM
  
```



400 MHz Frequency Hopping is a order option (C1S, C2S) and must be specified at the time of order and set at the factory.



Both frequency tables (ATP0 & ATP1) must be populated before changes can be saved & modem can be brought online.

Image 5-7: AT&F3 Point to Multipoint Repeater

- A) AT&F3 - Sets the factory defaults for a Point to Multipoint Repeater.
- B) S128 - Must be set to 2 (ATS128=2) for 400 MHz Frequency Hopping Operation.
- C) AT&W - Writes the changes to NVRAM.
- D) AT&V - Displays the configuration as seen above.
- E) S105 - Every unit in a Point to Multipoint Network must have a unique unit address. The address of the Repeater is automatically set to 3.
- F) S140 - The destination address is the final destination to which all data is to be sent. In a Point to Multipoint Network this address is set to 1, the unit address of the Master, and should not be changed.
- G) S101 - The operating mode defines the unit type and is set to 1, which is a Repeater.
- H) S103 - Wireless Link Rate must be set to the same value of each unit in the system.
- I) S133 - The network type must be set to 0 for Point to Multipoint operation.
- J) S102 - The serial baud rate (and data format S110) must match that of the connected device.
- K) S104 - Each unit in a Network must have the same Network Address. To change the Network Address, the ATS104=XXXXXXX command can be used.
- L) S118 - If the repeater is to connect through another repeater, enter the unit address of the repeater here.

5.0 400 MHz Frequency Hopping Configuration

5.3.3 Unit Addressing

In a Point to Multipoint Network each unit must have a unique unit address, which can be configured using register S105. Duplicate addresses may result in unpredictable problems in the network. In a PMP Network data flow is such that data from the Master is sent to all units by setting the destination address (S140) to 65535, meaning data is broadcast to all units.

5.3.4 Retransmissions

Packet Retransmissions can be used to ensure data reaches its intended destination by re-sending the same packet over and over. In Point to Multipoint system data is not acknowledged by the destination, meaning data will be transmitted, an additional number of times specified by S113, resulting in a significant impact on system performance. The more times a modem retransmits data, the more the overall throughput of the system is reduced. To adjust the retransmission rate, use register S113, the default value is 5 (+ the initial transmission). Although, this number should be as low as possible to keep as much bandwidth in the system as possible.



400 MHz Frequency Hopping is an order option (C1S, C2S) and must be specified at the time of order and set at the factory.

S113 = 5 - Packet Retransmissions (0-254)

Retransmissions are typically used in noisy environments to combat interference and low signal strength, ensuring data is received at the intended destination.

5.3.5 Network Synchronization

Network Synchronization is what allows all units to hop from frequency to frequency at the same time.

For units to synchronize with the network, each unit must have the same:

- Network ID (S104)
- Network Type (S133)

Sync Timeout

Once synchronized to the network the unit does not need to receive sync data often to keep track of where the system is supposed to be (in time and frequency). The sync Timeout defines the number of hops where no sync data is received from a Master and/or Repeater before losing sync. In other words, how long a unit will remain synchronized with the network without receiving any sync packets before it gives up and loses sync.

S248 = 100 Sync Timeout (4-65534)

Setting a value too low will cause the unit to lose sync easily and time will be wasted trying to re-sync to the network. Several hops can go by without receiving a sync packet, and this is completely normal. If this value is set too high, the unit will assume for a long time that the network is still out there, when especially in mobile applications, it may not be.

5.0 400 MHz Frequency Hopping Configuration

5.3.6 Point-to-Multipoint TDMA (Standard TDMA)

Time Division Multiple Access (TDMA) is available as a special form of the PMP network topology.

In Standard TDMA mode, a list of remote units is configured in the Master modem, the Master unit then cycles through the list and indicates to the remote when it is able to transmit its data. The remote unit would then begin sending data, if it had data to send, and then release the channel when no longer needed. This would indicate to the master unit to queue the next unit and so on.

In this mode each slave unit has the channel or right to broadcast, for varying lengths of time, and if a remote did not respond, the Master would need to time out before moving on to the next unit in the list. The maximum number of Remotes which can communicate with a Master in this configuration is 2^{13} (8192).

To configure a Standard TDMA network, the default settings described in 5.3 are applicable, with the exception that the following registers on the Master must be modified as required:

- S244 Channel Request Mode
- S251 Master Hop Allocation Timeout

For TDMA, set S244=1. (Must be set on Master and all Slaves)

The default for S251 is 10 (hop intervals). If the system is to be deployed in a 'clean' RF environment, this number should perhaps be reduced to 2 or 3 to provide enough time for the Slave to initiate its response but to not potentially waste a significant number of hop intervals waiting for an unresponsive Slave to send data.

In addition, the following AT commands (ref. Section 6.1) are used to populate, view and change the Registered Slaves List:

- T? view entire Registered Slaves List
- Tn= UA enter a Slave's Unit Address (UA) into the Registered Slave's List item number n , where $n=0-8191$, and UA = 0-65534 (selecting a UA value of 0 terminates the list)
- Tn? view Registered Slaves List entry number n , where $n=0-8191$. Response is UA of List entry

The default Registered Slaves list consists of 8192 entries (0-8191), populated with Unit Addresses of 2 thru 8193 respectively.

On the following page is an example to illustrate basic TDMA operation. For an actual deployment, application-specific parameters must be considered and other various modem configuration options optimized accordingly.



400 MHz Frequency Hopping is a order option (C1S, C2S) and must be specified at the time of order and set at the factory.

5.0 400 MHz Frequency Hopping Configuration

Example:

5 Slaves, configured with PMP defaults (&F2). Unit Addresses: 3, 7, 10, 15, and 21. UA 3 has some data, 7 has no data, 10 has data, 15 is powered-off, and 21 has data but its RF connection is very intermittent due to an intermittent outdoor antenna connection. Master has been configured as PMP default Master (&F1). Clean RF environment.

Changes to be made to the Master:

S244=1
S251=3
ATT0=3
ATT1=7
ATT2=10
ATT3=15
ATT4=21
ATT5=0 (this terminates the list)



400 MHz Frequency Hopping is a order option (C1S, C2S) and must be specified at the time of order and set at the factory.

The Master will 'poll' (give the opportunity to transmit) the Slave with UA 3. This Slave will transmit all of its data and then inform the Master of same.

On the next hop, the Master will sequence to the next modem, UA 7. Slave 7 will inform the Master it has no data and on the next hop, the Master will sequence to UA 10.

Slave 10 will transmit its data and inform the Master when complete.

The Master then polls unit 15, no response. On the next hop interval, the Master will poll unit 15 again: no response. It will poll one more time on the following hop interval and, with no response, will move on to poll UA 21 which has data and sends it to the Master—but due to the faulty outdoor antenna connection, the Master does not receive the message from the Slave indicating that it has sent all of its data, so the Master will wait for the value of S251 (3 hops) for such a message from the Slave before moving on to begin the cycle again at UA 3.

5.0 400 MHz Frequency Hopping Configuration

5.3.7 Peer-to-Peer (P2P)

P2P mode is used for communications between pairings of Remote modems,

e.g. Slave 12 can exchange data with (only) Slave 14, Slave 6 can exchange data with (only) Slave 7, etc.



A P2P network requires a Master modem.

The data being transmitted from one Slave to another in P2P mode is transferred via the Master.

There are no specific factory default settings for P2P modems.

To establish a basic P2P network:

Master

- enter into Command Mode
- load the &F1 factory default settings
- Change modem type (S128) to 2
- change the Network Type (S133) to 2
- change Packet Retransmissions (S113) from 5 to 0 (increase from 0 if required)
- save the change using the AT&W command
- go online with the ATA command

Slave 1

- enter into Command Mode
- load the &F2 factory default settings
- Change modem type (S128) to 2
- change the Network Type (S133) to 2
- change the Destination Address to 3 (to be the UA of Slave 2)
- save the change using the AT&W command
- go online with the ATA command

Slave 2

- enter into Command Mode
- load the &F2 factory default settings
- Change modem type (S128) to 2
- change the Network Type (S133) to 2
- change the Unit Address (S105) to 3
- change the Destination Address to 2 (the UA of Slave 1)
- save the change using the AT&W command
- go online with the ATA command

The Master will broadcast (actually 're-broadcast') the data incoming to it from both Slaves to all (2) Slaves; one Slave's data has a destination being the other Slave and vice versa.



400 MHz Frequency Hopping is an order option (C1S, C2S) and must be specified at the time of order and set at the factory.

5.0 400 MHz Frequency Hopping Configuration

5.3.8 Everyone-to-Everyone (E2E)

E2E mode is used for communications between all remote modems,

i.e. data from every modem is broadcast to every other modem in the network.

Considering the amount of data re-broadcasting (via the Master), it is a very bandwidth-intensive network topology.

There are no specific factory default settings to configure modems for E2E operation.

To establish a basic E2E network:



An E2E network requires a Master modem.

The data being transmitted from remote units in an E2E network travels to the Master and is then re-broadcast to all other remotes.

Master

- enter into Command Mode
- load the &F1 factory default settings
- Change modem type (S128) to 2
- change the Network Type (S133) to 2
- change Packet Retransmissions (S113) from 5 to 0 (increase from 0 if required)
- save the change using the AT&W command
- go online with the ATA command

Slaves

- enter into Command Mode
- load the &F2 factory default settings
- Change modem type (S128) to 2
- change the Network Type (S133) to 2
- change the Unit Address (S105) to a unique number (range: 2-65534)
- change the Destination Address to 65535 (the broadcast address)
- save the change using the AT&W command
- go online with the ATA command



400 MHz Frequency Hopping is a order option (C1S, C2S) and must be specified at the time of order and set at the factory.

6.0 Register/Command Reference

6.1 AT Commands

Appendix B is a quick reference for the available AT commands; in this sub-section are details regarding the most commonly used. To invoke an AT command, enter Command Mode, then type **AT <command>[Enter]**.



If changes were made to the modem's configuration and it is intended that those changes be saved to non-volatile memory, do so with the AT command '&W' prior to placing the modem online.

A	Answer
---	--------

Upon completion of tasks being done with the modem in Command Mode, invoking this command will place the modem back 'online' (into Data Mode).

g, G (FH Modems)	Spectrum Analyzer
------------------	-------------------

This is a very useful feature of the SDR400. ATg or ATG will provide a display of signal levels received within the operating environment and frequency range of the modem under test. ATg averages 256 samples, ATG 16,000.

Invoking the ATg command causes the SDR400 to sweep the operating band and provide a display of both the mean and peak signal levels, in dBm, found on each channel.

The 'graphical' display is limited from -110dBm to -53dBm, and is in 1dB increments. Ignore the leftmost asterisk in calculations (as below).

How to interpret the display (example):

...		
ch 78 -137dBm *		No signal was measured on channel 78.
ch 80 -105dBm *****...		Mean signal level: -(110-5 (asterisks)) = -105dBm
...		Peak signal level: -(110-5 (asterisks) -3 (dots)) = -102dBm

For the SDR400 @ 900 MHz Channel 1 is at 902.4MHz, with subsequent channels in increments dependent on the link rate. Therefore, to calculate the frequency of channel n : (BW = Channel Bandwidth in MHz)

$$\text{Freq channel } n = 902.4 + ((n-1) \times \text{BW})\text{MHz.}$$

In	Identification
----	----------------

The I command returns information about the SDR400.

- | | |
|------------|---|
| 1 | Product Code |
| 3 | Product Identification (Firmware Version) |
| 4 | Firmware Date |
| 5 | Firmware Copyright |
| 6 | Firmware Time |
| 255 | Factory-Configured Options listing |

6.0 Register/Command Reference

ATlogin

Login

AT Login can be used to enable a password prior to accessing command mode and changing any configuration parameters. The modem must be restarted before settings will be enabled.

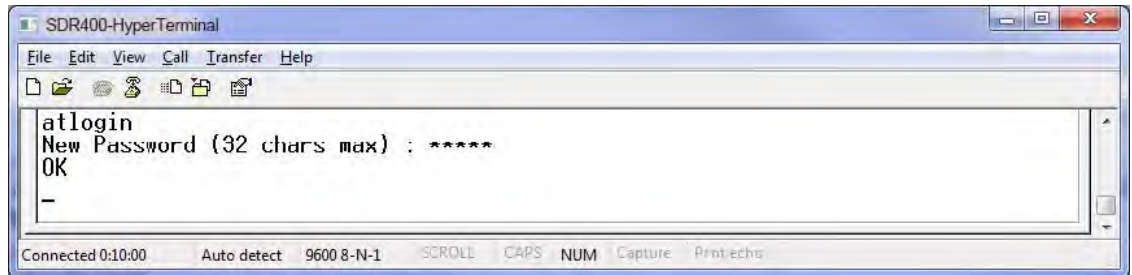

Image 6-1: AT login

N

Advanced Spectrum Analyzer

The Advanced Spectrum Analyzer feature provides for a very detailed analysis of a particular area of the radio frequency spectrum within which the SDR400 operates.

The specific start (of scan) and stop frequencies, along with step (increment) size and dwell (on frequency) time are user-definable.

Following is the format for the ATN command:

In Command Mode

ATN F_{start} F_{stop} S D[Enter]

where

- F_{start} = start frequency in MHz (including 0-6 decimal places)
- F_{stop} = stop frequency in MHz (including 0-6 decimal places)
- S = step increment in kHz (from 1-1000)
- D = dwell time in ms (from 1-1000)

Example:

ATN 905.250 908.500750 25 100

Note: Be sure to enter spaces as shown in the format detailed above.

6.0 Register/Command Reference

&Fn

Load Factory Default Configuration

Loading Factory Default settings allow for quick configuration of systems by setting a known starting point with factory recommended settings for each type of unit. The Factory settings change all settings required to initiate default communication with other unit types.

Values

Frequency Hopping (FH) modems

&F1 FH Master Fast PMP
 &F2 FH Slave Fast PMP
 &F3 FH Repeater Fast PMP
 &F4 FH Master Slow PMP
 &F5 FH Slave Slow PMP
 &F6 FH Master Fast PP
 &F7 FH Slave Fast PP
 &F8 FH Master Slow PP
 &F9 FH Slave Slow PP
 &F10 FH Master Fast PMP no Time ACK
 &F11 FH Master Fast P2P no Time ACK
 &F12 FH Master Fast PP no Time ACK
 &F15 FH Master WL
 &F16 FH Slave WL
 &F18 FH Master Fast TDMA
 &F19 FH Slave Fast TDMA

Narrow Band (NB) modems

&F51 - NB Transparent Protocol, Rate=9.6kbps, BW=25kHz, 2FSK
 &F52 - NB Transparent Protocol w Rep., Rate=9.6kbps, BW=25kHz, 2FSK
 &F53 - NB Pac.Crest Trans.Protocol, Rate=9.6kbps, BW=25kHz,FEC On,2FSK
 &F54 - NB Trimtalk 450s Protocol no Rep., Rate=9.6kbps, BW=25kHz, 2FSK
 &F55 - NB Trimtalk 450s Protocol Rep.1, Rate=9.6kbps, BW=25kHz, 2FSK
 &F56 - NB Trimtalk 450s Protocol Rep.2, Rate=9.6kbps, BW=25kHz, 2FSK
 &F57 - NB Trimtalk 450s Protocol Base w Rep., Rate=9.6kbps, BW=25kHz, 2FSK
 &F58 - NB Satel 3AS Protocol, Bit Rate=9.6kbps, BW=12.5kHz, 4FSK
 &F59 - NB Satel 3AS Protocol, Bit Rate=19.2kbps, BW=25kHz, 4FSK
 &F60 - NB Satel 3AS Protocol, BitRate=9.6kbps,BW=12.5kHz,FEC Off,4FSK,Type 1
 &F61 - NB Satel 3AS Protocol, BitRate=19.2kbps,BW=25kHz,FEC Off,4FSK,Type 1
 &F62 - NB Pac.Crest Trans.Protocol, Bit Rate=4.8kbps,BW=12.5kHz,FEC On,2FSK
 &F63 - NB Trimtalk Protocol, Bit Rate=4.8kbps, BW=12.5kHz, 2FSK
 &F64 - NB Pac.Crest 4FSK Protocol,BitRate=9.6kbps,BW=12.5kHz,FEC On,4FSK
 &F65 - NB Pac.Crest 4FSK Protocol,BitRate=19.2kbps,BW=25kHz,FEC On,4FSK
 &F66 - NB Pac.Crest FST Protocol,BitRate=9.6kbps,BW=12.5kHz,FEC On,4FSK
 &F67 - NB Pac.Crest FST Protocol,BitRate=19.2kbps,BW=25kHz,FEC On,4FSK
 &F68 - NB Pac.Crest FST Protocol,BitRate=9.6kbps,BW=12.5kHz,FEC On,4FSK,Type2
 &F69 - NB Pac.Crest FST Protocol,BitRate=19.2kbps,BW=25kHz,FEC On,4FSK,Type2
 &F70 - NB Trimtalk 450s Protocol, BitRate=8kbps, BW=12.5kHz, 2FSK
 &F71 - NB Trimtalk 450s Protocol, BitRate=16kbps, BW=25kbps, 2FSK

&F100 - Reset Hopping Modes

6.0 Register/Command Reference



All modems in the network must have the same frequency restrictions configured within them.



Use the ATg or ATG feature to help identify the frequency/range of possible interfering signals within the 902-928MHz ISM band, and then use the AT&H0 feature to configure the modem to avoid them.

&H0

Frequency Restriction

By default, the SDR400 (900MHz Mode) will hop on frequencies across the entire 900MHz ISM band. For some applications or within certain operating environments, it may be desired to prohibit the modem from operating on specific frequencies or range(s) of frequencies. The modem will not allow 'too many' frequencies to be restricted; it requires a certain amount of bandwidth within which to operate to comply with regulations.

Following is an example of entering Frequency Restrictions. First, the AT&H0 command is invoked:

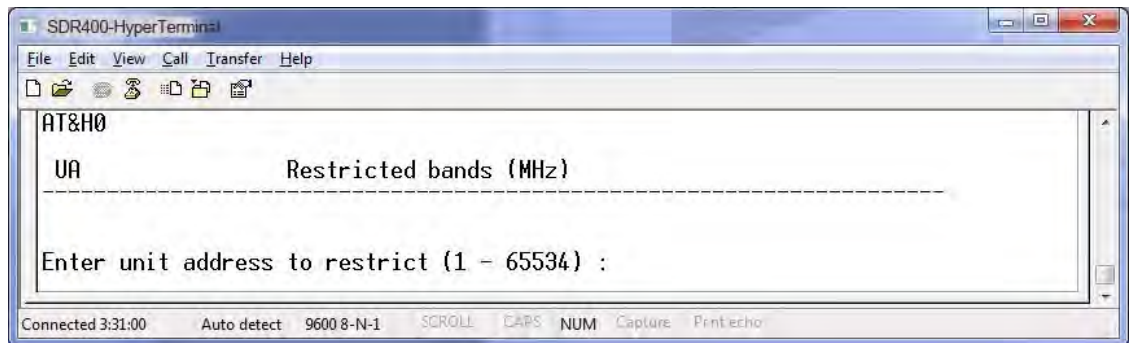

Image 6-1: Frequency Restriction

The modem responds with a prompt for the Unit Address. (Enter the Unit Address for the Master (1) and all Repeaters in the network into each modem in the network.) Having entered '1', the modem prompts for the first restricted frequency to be entered.

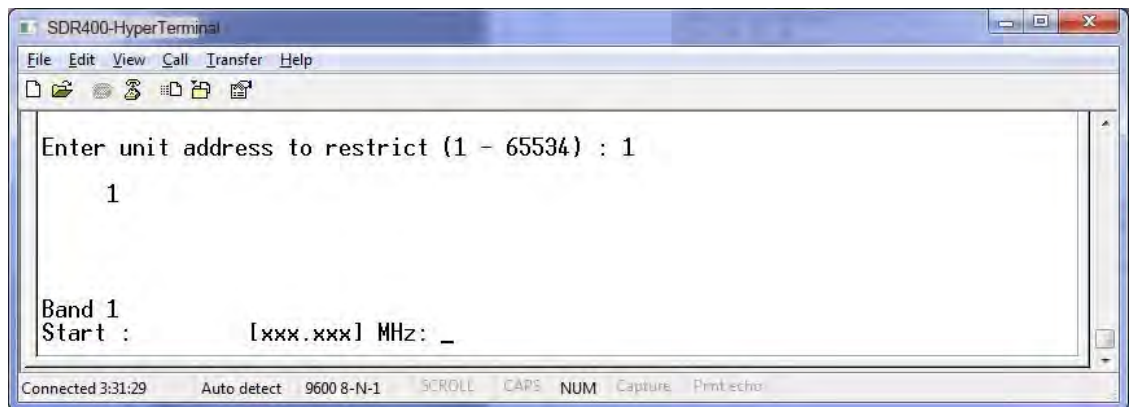

Image 6-2: Unit Address

6.0 Register/Command Reference

&H0

Frequency Restriction (continued)

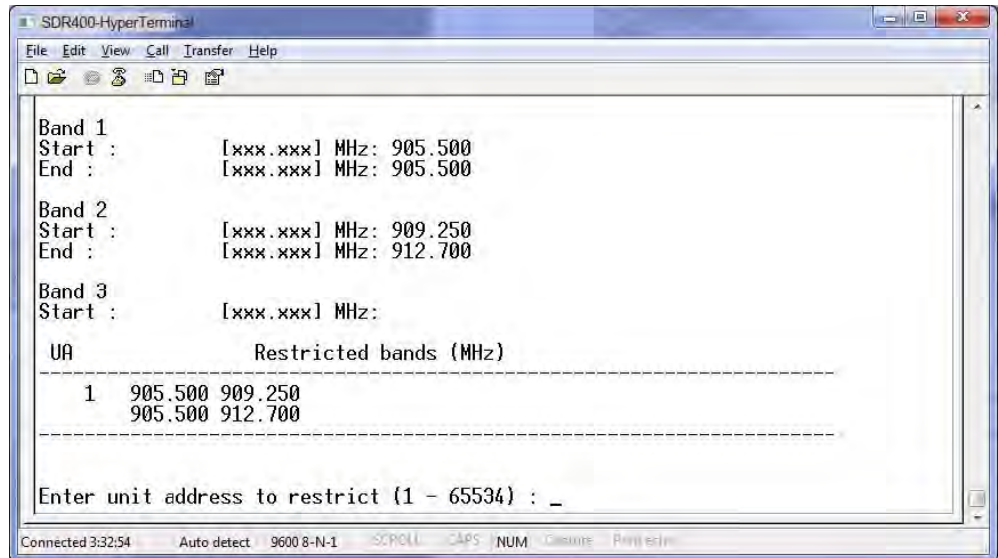

Image 6-3: Restricted Bands

905.500 was entered as the 'start' and 'end' of Band 1; this will restrict the frequency of 905.500MHz. The range of 909.250 to 912.700MHz was defined as the second (Band 2) restriction. When prompted to enter Band 3, the [Esc] key was entered to escape the entry process and the summary at left/bottom was displayed. Pressing [Esc] again saves and exits the process. To modify an existing restriction, simply overwrite it. To remove a restriction, overwrite it with 000.000.

&H1 (FH Modems – 900MHz)

Repeater Registration

When more than one Repeater exists in a network, the Unit Address of each Repeater should be registered within **every modem** in the network. The reason for doing this is to enable the modems to create hopping patterns which will be orthogonal to each other, thereby minimizing possible interference between network segments.

Upon entering the AT&H1 command, the modem prompts as follows:

- **A** to add a Repeater (this is done by entering the Unit Address of the Repeater)
- **R** to remove a Repeater
- **C** to clear all registered Repeaters.

Pressing the [Esc] key saves and exits the process.

&V

View Configuration

Displays S Register names and current values.

&W

Write Configuration to Memory

Stores active configuration into the modem's non-volatile memory. Any changes made to the SDR400 Series must be written to NVRAM using the AT&W command (AT&WA will write the changes & set unit in online mode)

6.0 Register/Command Reference

P0? (400 MHz Modes)

Frequency Table

The SDR400 Frequency Table shows the available licensed frequencies and occupied bandwidth for each channel, as well as the direction of communication allowed on that channel. Use the ATP0? Command to view the table. The for NB modems the table can only modified by the factory or an authorized dealer. The contents of the table are dependant on licensing. Contact your dealer or Microhard Systems Inc, for more information.

Channel Number	Frequency(MHz)	BW	DIR
0	410.000000	25 KHz	Rx&Tx
1	415.000000	25 KHz	Rx&Tx
2	420.000000	25 KHz	Rx&Tx
3	412.000000	25 KHz	Rx&Tx
4	450.000000	25 KHz	Rx&Tx
5	460.000000	25 KHz	Rx&Tx
6	422.000000	25 KHz	Rx&Tx
7	414.500000	25 KHz	Rx&Tx
8	440.000000	25 KHz	Rx&Tx
9	440.000000	12.5 KHz	Tx
10	450.000000	6.25 KHz	Rx
11	465.000000	12.5 KHz	Tx
12	440.000000	6.25 KHz	Rx&Tx
13	440.000000	25 KHz	Rx&Tx
14	430.000000	25 KHz	Rx&Tx
15	475.000000	12.5 KHz	Tx
16	480.000000	25 KHz	Rx&Tx
17	406.200000	25 KHz	Rx&Tx
18	440.000000	25 KHz	Rx&Tx
19	440.000000	25 KHz	Rx&Tx
20	440.000000	25 KHz	Rx&Tx

As shown above, the ATP0? Command will display the contents of the table in the following format:

Channel Number Frequency (MHz) BW DIR

Channel Number: 0 - 63.

Frequency (MHz) = 410 to 480.0 MHz

BW = Occupied Bandwidth, (6.25kHz / 12.5kHz / 25kHz)

DIR = Direction, (Rx / Tx / Rx&Tx)

6.0 Register/Command Reference

6.2 Settings (S) Registers

The majority of modem configuration is done via the Settings (S) Registers.

The previous sections provide configuration detail related to different operating modes and network topologies; this section examines each S register in detail for reference or advanced/custom networks. Appendix C is a quick reference for the S register options.

In the following descriptions, default settings (where applicable) are in **boldface**. In Command Mode,

Query format: **ATS<S register #>?** [Enter]
 Change format : **ATS<S register #>=<value>** [Enter]
 Help format: **ATS<S register #><space>/?** [Enter]

The SDR400 is a multi-Frequency Modem that can operate in several different modes as discussed in previous sections. The registers applicable for each mode, and network/protocol type may vary. Where possible, it has been noted in the title box if the register is only used in specific modes.

NB = Narrowband, Licensed Modes (400 MHz)
 FH = Frequency Hopping Modes (400 MHz and/or 900 MHz)

y <command	command name> x						
<p>S0</p> <p>This register determines in which mode the modem will be upon power-up. If selected to power-up in Command Mode, the modem will be offline from the wireless network, and ready to be configured upon power-up. The typical mode of operation is for the modem to power-up in Data mode: ready to participate in data transfer over the wireless network.</p>	<p>Power-up Mode</p> <table border="1"> <thead> <tr> <th colspan="2">Values</th> </tr> </thead> <tbody> <tr> <td>0</td> <td>up in Command Mode</td> </tr> <tr> <td>1</td> <td>up in Data Mode</td> </tr> </tbody> </table>	Values		0	up in Command Mode	1	up in Data Mode
Values							
0	up in Command Mode						
1	up in Data Mode						
<p>S2</p> <p>Escape character. If >127, escape feature is disabled. Modification of this register may be necessary when connecting the modem to a telephone modem where the +++ character string may result in undesired consequences.</p>	<p>Escape Code</p> <table border="1"> <thead> <tr> <th colspan="2">Values</th> </tr> </thead> <tbody> <tr> <td colspan="2">any ASCII value</td> </tr> <tr> <td colspan="2">+ (decimal 43)</td> </tr> </tbody> </table>	Values		any ASCII value		+ (decimal 43)	
Values							
any ASCII value							
+ (decimal 43)							
<p>S51 (NB Modems)</p> <p>RSSI Threshold in CSMA mode (for NB modems), dB: -127 ... 0. 0 - CSMA mode is not used, modem will transmit regardless of free/busy channel. The channel is busy if the RSSI of the received signal is stronger than the value saved in S51. Default - 100.</p>	<p>RSSI Threshold</p> <table border="1"> <thead> <tr> <th colspan="2">Values</th> </tr> </thead> <tbody> <tr> <td colspan="2">-100</td> </tr> </tbody> </table>	Values		-100			
Values							
-100							

6.0 Register/Command Reference

S101

Operating Mode

The Operating mode defines the role in the network a unit plays. A SDR400 modem may be configured for any role required within a radio network.

Master: Only one per network. In PP/PMP network types (see S133) data either originates at, is destined to, or passes through the Master.

Repeater: May act simply as a 'Repeater' to store and forward data to/from an upstream unit to/from a downstream unit (e.g. when there is a long distance between units), or, may act as a Repeater/Slave in which case the above function is performed AND the unit may also exchange data as a Slave within the network.

Slave: Interfaces with remote devices and communicates with Master either directly or via Repeater(s).

Values

FH Modems

0 - Master
1 - Repeater
2 - Slave (Remote)

NB Modems (Protocol Dependent)

0 - Master (Base) for Trimtalk
1 - Repeater
2 - Slave (Remote)
3 - Repeater 2 for Trimtalk

S102

Serial Baud Rate

The serial baud rate is the rate at which the modem is to communicate with the attached local asynchronous device. This value must match the PC or serial device that is connected to data port on the SDR400.

When forcing a module to Command Mode the data port will temporarily communicate at the default value. When the SDR400 is returned to Data Mode, the serial port settings are returned to those specified in S102 and S110.

Values (bps)

0	230400	8	7200
1	115200	9	4800
2	57600	10	3600
3	38400	11	2400
4	28800	12	1200
5	19200	13	600
6	14400	14	300
7	9600		



Note: Most PC's do not readily support serial communications greater than 115200bps.

S103

Wireless Link Rate

This register determines the rate at which RF communications will occur over a given network. All modems within a particular network must be configured with the same wireless link rate. Faster link rates result in greater throughput, however, for each 'step' increase in link rate, there is an approximately 1dB reduction in sensitivity.

Values (bps)

Frequency Hopping modems:

0 - 19200
1 - 115200
2 - 172800
3 - 230000
4 - 247000
5 - 340000
6 - 24700
8 - 57600

Narrow Band modems:

0 - 1200
1 - 2400
2 - 3600
3 - 4800
4 - 7200
5 - 9600
6 - 14400
7 - 19200
8 - 16000

6.0 Register/Command Reference



Change the default value for the Network ID to something unique for your network. Do this for an added measure of security and to differentiate your network from others which may be operating nearby.

S104 (FH Modems)

Network Address (ID)

All modems in a given network must have the same Network Address. This unique network address is not only a security feature for a particular network, but also allows other networks - with their own unique network address - to operate in the same area without the possibility of undesired data exchange between networks.

Values (0 - 4,000,000,000)

1234567890

S105

Unit Address

The unit address is, and must be, a unique identifier of each modem in a network. The address value is 16-bits in length.

Values (1-65535 or 1-255)

1

FH: The Master has by default, and must retain, a unit address of 1; 65535 is the broadcast address. Refer to the specific modem type for more information in regards to unit addressing.

NB: The unit address is used only by Microhard Transparent Mode, and Pacific Crest protocols (only lower byte(1-255))



Change S107 to something unique for your network.

S107

Static Mask

This mask is applied to the transmitted data, and removed from the received data. It is an added form of security for a network.

Values (up to 16 char)

default (the word itself)

For NB modems it is used by Pacific Crest protocol for security purposes. Default: Empty String

S108

Output Power

This setting establishes the transmit power level which will be presented to the antenna connector at the rear of the modem.

Values (dBm (mw))

20 (100)	26 (400)
21 (125)	27 (500)
22 (160)	28 (630)
23 (200)	29 (800)
24 (250)	30 (1W)
25 (320)	33 (2W)*

Unless required S108 should be set not for maximum, but rather for the minimum value required to maintain an adequate system fade margin.

** If supported by your model, factory enabled.*



FCC regulations allow for up to 36dBm effective isotropic radiated power (EIRP). The sum (in dBm) of the transmitted power, the cabling loss, and the antenna gain cannot exceed 36dBm.

6.0 Register/Command Reference

S109 (FH Modems)

Hop Interval

This register is effective only on the Master and is responsible for establishing the rate at which all modems within a particular network change frequency (hop - from frequency to frequency).

Long hop intervals typically result in the greatest data throughput, however shorter hop intervals may decrease latency, particularly of smaller packets of data.

The default setting of 20ms is satisfactory for most applications. If adjustment of S109 is being considered, also consider the serial baud rate, wireless link rate, and maximum packet size (S102, S103, and S112).



Hop Interval S109 should only be changed if recommended by Microhard Support and/or for specific applications!

S109	time (ms)	S109	time (ms)	S109	time (ms)	S109	time (ms)
0	1.498	16	89.997	32	11.997	48	21.998
1	2.001	17	99.998	33	12.500	49	22.999
2	2.498	18	125.000	34	12.998	50	24.000
3	3.002	19	150.001	35	13.501	51	25.001
4	3.997	20	4.500	36	13.998	52	26.001
5	4.997	21	5.501	37	14.502	53	27.002
6	6.999	22	5.998	38	15.502	54	27.997
7	10.001	23	6.501	39	16.000	55	28.998
8	14.999	24	7.502	40	16.497	56	8.335
9	19.997	25	8.000	41	17.001	57	199.997
10	29.999	26	8.497	42	17.498	58	250.000
11	40.000	27	9.000	43	18.001	59	300.002
12	50.002	28	9.498	44	18.499	60	349.998
13	59.998	29	10.499	45	19.002	61	378.997
14	69.999	30	11.002	46	19.499		
15	80.001	31	11.499	47	20.998		

Table 6-1: Hop Interval (S109)

S110

Data Format

This register determines the format of the data on the serial port. The default is 8 data bits, No parity, and 1 Stop bit. The value must match the PC or Serial Based device that is connected to the data port.

When forcing a module to Command Mode the data port will temporarily communicate at the default value. When the SDR400 is returned to Data Mode, the serial port settings are returned to those specified in S102 and S110.

Values

1	8N1	6	7N2
2	8N2	7	7E1
3	8E1	8	7O1
4	8O1	9	7E2
5	7N1	10	7O2

6.0 Register/Command Reference



In a PMP system, set S113 to the minimum value required as, effectively, the data throughput from Master to Remote is divided by 1 plus the number stored in S113.

S111

Packet Min Size

This is the minimum number of collected bytes in one buffer before the buffer can be closed by the character timeout timer controlled by S116. Typically should not be modified.

Values (1 - 255)

1

S112

Packet Max Size

Determines that maximum number of bytes from the connected device that should be encapsulated into a packet. Large packet sizes may produce the best data throughput; however, a smaller packet is less likely to become corrupted and, if it does, is retransmitted with a lesser impact on network traffic.

Values (1 - 256)

FH: 256
NB: 1579

The default setting of 256 bytes is suited to most applications in frequency hopping modems. Narrowband modems use 1579.

S113

Packet Retransmissions

This register determines the maximum number of times that a packet will be retransmitted (in addition to the initial transmission). Retransmissions can be used to provide system robustness and to ensure data delivery due to noisy environments or weak signal levels. Retransmissions should not be used as the only means to correct for data collisions. Retransmissions create additional traffic and can have a significant impact on overall throughput of a system.

Values (0 - 254)

5

See register S213 for Repeaters.

S115

Repeat Interval

In *PP/PMP* S115 determines the number of slots which are available within a window of opportunity for Remote units to submit channel requests to the Master modem. For a large number of remotes, the value of S115 should be set relatively high:

Values (0 - 255)

3

Remotes will randomly contend for the ability to access the channel request slots. For a small number of Remotes, it is advisable to keep S115 closer to the default value so as to not 'waste bandwidth' by maintaining a relatively large window housing a greater-than-necessary number of channel reservation request slots.

In a TDMA-type system, S115 may be set to 1 as the Remotes are not able to request a transmission channel: the Master polls each Remote for data.

For NB modems it is used as a maximum number of randomly selected time slots for checking carrier sense detector, it is used in CSMA when repeaters are enabled (S141=1)

6.0 Register/Command Reference

S116

Character Timeout

Character Timeout in 1/4 of character time (0-255). Default = 10 (2.5 character time). This 'timer' looks for gaps in the data being received from the local attached device. The timer is activated after the Minimum Packet Size (S111, default 1 Byte) has been accumulated in the modem. If the timer detects a gap in the data exceeding the Character Timeout value, the modem will transmit the data.

Values (0 - 254)

10

The SDR400 will accumulate data in its buffers until either (a) Maximum Packet size (S112) has been accumulated, or (b) Minimum Packet Size (S111) has been accumulated AND the Character timeout has expired—whichever occurs first. If S116 is set to 0, the modem will buffer exactly the Minimum Packet size and then transmit that data.

For NB modems that use low latency protocols e.g. Microhard Transparent, Satel 3AS, the modem starts transmitting data after receiving the first data byte. The timeout is used just to terminate the transmission.

S118 (FH Modems)

Roaming

This feature allows a Remote unit to synchronize with a specified 'upstream' unit (either Master or Repeater). The options are as follows:

S118=65535: A Remote will synchronize with an upstream unit which has the same network address (S104) and static mask (S107) as the Remote. Should that upstream unit fail, this Remote will attempt to synchronize with another 'upstream' unit within the same network. This ability is particularly well-suited to mobile applications.

S118=1-254: In most static (fixed) networks, where there are no Repeaters, the default value of 1 is maintained: All Slaves synchronize to the Master (whose unit address is 1).

In networks where Repeaters are present, the value of a Remote's S118 corresponds to the particular upstream modem with which a particular Remote is intended to communicate, e.g. Slave UA (S105)=3 may have an S118=2, where the modem with UA 2 is a Repeater between the Slave and the Master; the Repeater will have an S118=1.

Values

65535 full roaming

1-254 specific (fixed) unit address with which to associate

1



A Master modem's RSSI LEDs will not illuminate to any degree until such time as it has received valid packets from a 'downstream' unit.

S119

Quick Enter to Command Mode

If this register is set to 1, a delay of 5 seconds is introduced at power-up before the modem will go into Data Mode. If, during these 5 seconds, the user enters 'mhx' the modem will instead go into Command Mode and reply with 'OK'. The terminal baud rate must be set to 9600bps. If an incorrect character is entered, the modem will immediately go into Data mode.

The default setting is 0: The modem will promptly go into Data Mode upon power-up.

Values

0 disabled

1 enabled

6.0 Register/Command Reference

S123 RSSI from Uplink (dBm)

This register displays the average signal strength received over the previous 8 hop intervals from a Master/Repeater. The value in this register is also reflected in status lines RSSI1, 2, and 3, which connect to the modem's RSSI LEDs.

Values (dBm)

-110 to -55dBm (max reading)

The 'ATS123 /?' command will show the RSSI statistics for FH modems (min, max, average, channel, frequency).

NB modems have a 10 second timeout for keeping RSSI, after it is expired, an (N/A) value will be returned and RSSI LEDs will start scanning.

S124 (FH Modems) RSSI from Downlink (dBm)

This register displays the average signal strength received over the previous 8 hop intervals from a Slave/Repeater. The value in this register is also reflected in status lines RSSI1, 2, and 3.

Values (dBm)

-110 to -55dBm (max reading)

The 'ATS124 /?' command will show the RSSI statistics for FH modems (min, max, average, channel, frequency). It is not used by NB modems.

S125 (NB Modems) Occupied Bandwidth

This register sets the occupied bandwidth for the wireless link. It is only used by NB modems. See table 3.2 for supported combinations of link rate (S103) and BW. The maximum bandwidth must be determined and set by your dealer in the frequency/channel tables (ATP0? / ATP1?).

Values

0	6.25 kHz
1	12.5 kHz
2	25 kHz

S127 (NB Modems) Modulation

This register sets the modulation scheme for the modem. Available Link Rate and Channel Bandwidth vary based on the modulation scheme.

Values

0	2FSK
1	4FSK

S128 Modem Type

The SDR400 can operate as a 400 MHz Licensed, Narrowband Modem, as a 900 MHz FHSS Modem or as a 400 MHz Frequency Hopping Modem. The Modem Type defines the basic operating mode of the entire modem module. This register should be set before any other parameters are configured if you are configuring your modem manually.

Values

0	400 MHz Narrow Band (NB)
1	900 MHz Frequency Hopping
2	400 MHz Frequency Hopping

It is strongly recommended to use default setting (AT&F...) commands as a start point.

400 MHz Frequency Hopping is only available in C1S and C2S models and must be specified at time of order.

6.0 Register/Command Reference

S129 (NB - 3AS Only) Full CRC Use

Full CRC Check (for 3AS Protocol). 0 - Disable, 1 - Enable

Values

0 - Disable
1 - Enable

S130 (FH Modems) No Sync Intake

Defines if the modem will accept data when/if the remote has become unsynchronized from the Master. If set to 0, this function will be disabled and any data received will be ignored. If set to 1, the modem will accept data and buffer it until the unit is synchronized.

Values

0 - Disabled
1 - Enabled

S131 (NB Modems) Main Tx Frequency

This register sets the operating Tx frequency for the wireless link. Select the desired channel from the frequency table. *The available channels/frequencies are entered into the channel table by Authorized Dealers only.* Use the "ATP0?" command to view the available channels.

Values

Channel #
0 - 63

S132 (NB Modems) Main Rx Frequency

This register sets the operating Rx frequency for the wireless link. Select the desired channel from the frequency table. *The available channels/frequencies are entered into the channel table by Authorized Dealers only.* Use the "ATP0?" command to view the available channels.

Values

Channel #
0 - 63

S133 (FH Modems) Network Type

This register defines the type of network being deployed. This register must be set to the same value on every unit in the system.

Point to Multipoint - The Master broadcasts data to all units, and all remote units send data back to the Master.

Point to Point - Point to point traffic between a Master and a Slave (with 0 or more Repeaters in between).

Peer-to-Peer involves either communication between 2 (typically remote) units (P2P) or between all units (Everyone-2-Everyone - E2E).

Values

0 - Point to Multipoint (PMP)
1 - Point to Point (PP)
2 - Peer to Peer or Everyone to Everyone.
3 - Reserved
4 - PMP with acks

S136 (NB Modems) TX_RX Priority

Determines which mode (Tx or Rx) has priority.

Priority Tx: If the modem has data to Transmit and waits for a free channel, 'After Tx delay' or 'Tx Attack' time-outs to expire in order to start transmission, the modem will ignore all data received from the air.

Priority Rx: Same conditions as above, but the modem will accept data from the air if it is waiting to transmit.

Values

0 - Priority Tx
1 - Priority Rx

6.0 Register/Command Reference

S137 (NB Modems) CSMA Time Slot Size

Size of Time Slot in bytes (For Transparent and other protocols, used in CSMA mode with Repeaters). Range from 0 to 255. Default - 2.

Values

2

S138 (NB Modems) After Tx Delay

After Tx Delay, in 100us (For Transparent and other protocols, used in CSMA mode with Repeaters). Range from 0 to 65535. Default - 0.

Values

0

The modem will not send new data after completing a transmission of a data packet until the 'After Tx Delay' timeout has expired.

S139 (900 MHz FH Modem) Compatible_921 at 345

If this register is set and the SDR400 is configured as a 900 MHz FHSS modem, it will be compatible with the MHX921 operating at a link rate of 345kbps.

Values

0 - Disabled
1 - Enabled

S140 (FH Modems) Destination Address

As the name implies, this register specifies the ultimate destination for a modem's data.

Values

Varies by network and unit type

Different network topologies dictate the configuration of S140.

In **PMP** and **PP** modes - the range is 1 to 65535, where 65535 is broadcast:

- PMP - Master S140=65535, Remote S140=1
- PTP - Master S140=UA of Remote, Remote S140=1 (Master)
- P2P - Master S140=65535, S140 of each (of 2 / pair) Remote modem is the UA of the other
- E2E - S140 of all modems=65535 (broadcast)

S141 Repeaters Y/N

For FH Modems, this register informs, and only applies to the Master, as to the presence of any Repeater(s) in the network. With one or more Repeaters in the system, a networks throughput is divided in half.

Values

0 - no repeater
1 - 1 or more repeaters

For NB Modems, this register is used to enable the CSMA mechanism when repeaters are present. It must be set up identically on all modems in the network.

S142 Serial Channel Mode

This register defines the physical serial interface which will be used for data communications.

Values

0 - RS-232 interface
1 - Half-duplex RS-485
2 - Full-duplex RS-485 (Tx switch)
3 - Full-duplex RS-485 (Tx on)

-ATS142=2 RS485 interface, Full duplex (4-wire), Tx driver is on only when data are being sent. This mode could be used for multi-drop systems.

-ATS142=3 RS485 interface, Full duplex (4-wire), Tx driver is on always. This mode has reduced Tx driver switching noise.



With one or more Repeaters in the system, a network's throughput is divided in half. Exercising the option of back-to-back 'Repeaters' - which requires 2 modems at a 'Repeater' site - eliminates the division of bandwidth.

If there is more than one Repeater in a network, the Repeaters should be 'registered'. See Section 6.1 AT&H1 Repeater Registration for how to accomplish this.

6.0 Register/Command Reference

S150 (FH Modems)

Sync Mode

This setting applies only to the Master modem. S150 dictates which sync mode the Master will use when it initially goes online. Quick sync mode results in the Master hopping very quickly, which will enable a downstream unit to become synchronized faster.

Values

0	normal sync
1	quick sync mode, wait for acknowledgement
2	quick sync mode, wait for timeout

A setting of 1 applies only in a point-to-point (PTP) configuration: the Master will stay in quick sync mode until such time as it receives an acknowledgement from its associated Slave, it will then remain hopping quickly for the number of hop intervals (8-255) defined by S152 (Fast Sync Hold on Ack), after which time it will go into normal sync mode.

A value of 2 results in the Master going into quick sync mode when it initially comes online and then remaining in that mode for the duration specified in S151 (fast sync timeout) and then return to normal sync mode.

S151 (FH Modems)

Fast Sync Timeout

This register settings applies only to a Master modem. Effective only when S150=2.

Defines how long, in milliseconds, a Master modem will stay in fast sync mode after it initially goes online.

Values

milliseconds (ms)
100-65000
200

S153 (FH Modems)

Address Tag

If enabled, the modem prepends 4 extra bytes to the data: first byte = 0x00, second = 0xFF, third = source unit address (high byte), fourth = source unit address (low byte).

Value

0	disable
1	enable

6.0 Register/Command Reference



If throughput is not of primary concern and there is an emphasis on providing the most robust data communications, FEC should be considered.

S158

FEC (Forward Error Correction) Mode

A number of FEC schemes are available with different coding rates.

FEC consumes significant bandwidth: depending on which coding rate is chosen, a number of coding bits are transmitted along with the 'data' bits. In 'noisy' or long-range communications environments, FEC may effectively increase throughput by decreasing the amount of packet retransmissions which would otherwise be required.

Communications range may also be extended with the use of FEC: at a certain distance where data would otherwise be unacceptably corrupted, employing FEC may be all that is required to maintain the integrity of that data at that distance.

In NB modems it is only used for Pacific Crest and Satel 3AS protocols.

Types of FEC available within the SDR400 (FH Modems):

Hamming (7,4)	:	Information rate 0.5, corrects 1 out of 7 bits
Hamming (15,11)	:	Information rate 0.66, corrects 1 out of 15 bits
Hamming (31,24)	:	Information rate 0.75, corrects 1 out of 31 bits
Binary BCH (47,36)	:	Information rate 0.75, corrects 2 bits
Golay (23, 12, 7)	:	Information rate 0.5, corrects 3 bits
Reed-Solomon (15,11)	:	Information rate 0.687, corrects 2 nibbles

Values

FH Modems

0	No FEC
1	Hamming (7,4)
2	Hamming (15,11)
3	Hamming (31,24)
5	Binary BCH (47,36)
6	Golay (23,12,7)
7	Reed-Solomon (15,11)

NB Modems

0	FEC off (Default for Satel 3AS)
1	FEC on (Default for PCC)

S163

CRC Check on Diag Port

Enables CRC checking of received data on local diagnostic port Default - 1 (enable), 0 - disable. Note that even if disabled, the incoming data must have two dummy bytes transmitted in place of CRC bytes. See the SDR400 Diagnostic Channel Protocol Manual for more information.

Values

0	- Disable
1	- Enable

S167

Tx Enable

Tx Enable 0 - Disabled, 1- Enabled (default)
Enables RF emission.

Modem will never transmit data if disabled, it will be in a listen only mode.

Values

0	- Disable
1	- Enable

6.0 Register/Command Reference

S185 (NB Modems)

Tx Attack Delay

Tx attack delay for NB repeaters, ms. 0 (default) - data is transmitted immediately, 1-65535 Tx attack delay in ms.

When the modem receives data on the COM port, it will wait to transmit data for the duration of the Tx Attack Delay time-out. It is used to avoid collisions by modems receiving data at the same time, if selected differently on all modems in a network.

Values

0

S186 (NB Modems)

Protocol Selection

When configured as Modem Type (S128) = 0, The SDR400 operates as a 400 MHz Licensed Narrowband modem. The Protocol Selection defines how the modem will operate within this mode. The SDR400 can operate as a transparent low latency modem, or can be configured to be compatible with various GPS transceivers.

Values

0 - Transparent MH
 1 - Pacific Crest Compatible
 2 - Trimtalk Compatible
 3 - Satel (3AS) Compatible
 4 - Pacific Crest FST Comp.

S187 (NB - Trimtalk Only)

Disc.Dupl.Downstr.Dat.

Discard Duplicated Downstream Data (Only for Trimtalk Protocol).

0 - Disabled (default),
 1 - Enabled

If enabled the modem will discard any data duplicated by repeaters by removing packets that have the same sequence number.

Do not change this register unless using the Trimtalk 450s protocol with repeaters.

Values

0 - Disabled (Default)
 1 - Enabled

S188 (NB - Trimtalk Only)

Strip Off Additional Data

Strip Off Additional Data added by modems configured as repeaters.

0 - Disabled (default),
 1 - Enabled

Do not change this register unless using the Trimtalk 450s protocol with repeaters.

Values

0 - Disabled (Default)
 1 - Enabled

S189 (NB - Trimtalk Only)

Enable Uplink

Used only on a Base unit, it enables uplink from repeaters.

0 - Disabled (default),
 1 - Enabled

Do not change this register unless using the Trimtalk 450s protocol with repeaters.

Values

0 - Disabled (Default)
 1 - Enabled

6.0 Register/Command Reference

<p>S190 (NB - PCC Only)</p> <p>Ignore Received Unit Address (only for Pacific Crest Protocol).</p> <p>0 - Disabled (default), 1 - Enabled, Received UA doesn't matter, only sequence number is important.</p> <p>Could be used for address filtering in Pacific Crest Compatible mode.</p>	<p>Ignore Received UA</p> <p>Values</p> <p>0 - Disabled (Default) 1 - Enabled</p>
<p>S191 (NB Modems)</p> <p>This register sets the operating Tx frequency for the downstream wireless link of the repeater. Select the desired channel from the frequency table. <i>The available channels/frequencies are entered into the channel table by Authorized Dealers only.</i> Use the "ATP0?" command to view the available channels.</p>	<p>Repeater Tx Frequency</p> <p>Values</p> <p>Channel # 0 - 63</p>
<p>S192 (NB Modems)</p> <p>This register sets the operating Rx frequency for the downstream wireless link of the repeater. Select the desired channel from the frequency table. <i>The available channels/frequencies are entered into the channel table by Authorized Dealers only.</i> Use the "ATP0?" command to view the available channels.</p>	<p>Repeater Rx Frequency</p> <p>Values</p> <p>Channel # 0 - 63</p>
<p>S213 (FH Modems)</p> <p>Packet Retry Limit(0 - 254). Valid only for repeater's uplink (from child to parent)</p>	<p>Packet Retry</p> <p>Values (0 - 254)</p> <p>5</p>
<p>S214 (FH Modems, NB - MH Transparent Mode)</p> <p>Enables the retransmission of Diagnostic Packets. Diagnostics Packet Retransmission(0 - 254). 0 - (default)</p> <p>See the SDR400 Diagnostics Manual for more information.</p>	<p>Diagnostics Packet Retransmission</p> <p>Values (0 - 254)</p> <p>0</p>
<p>S217 (FH Modems)</p> <p>For most applications, the default value of 0 - resulting in transparent operation - will be maintained in this register. Setting this register to a value of 1 specifies MODBUS operation, in which the modem will frame the output data and comply with MODBUS specifications. S217=2 configures the modem for DF1 filtering. In this mode, the PLC's address must match the Unit Address of the modem. Data not intended for a specific PLC/Modem pairing will be blocked from passing through the modem to the attached PLC.</p>	<p>Protocol Type</p> <p>Values</p> <p>0 transparent 1 MODBUS RTU 2 DF1 protocol, full-duplex, with address filtering</p>

6.0 Register/Command Reference

S223 Minimum RSSI

This register displays the minimum recorded 'signal strength received' since the unit was last placed into Data mode. (Online). Modem shows RSSI based on its mode of operation, eg. Master or Slave.

Values (dBm)

-120 to -55dBm

S224 Maximum RSSI

This register displays the maximum recorded 'signal strength received' since the unit was last placed into Data mode. (Online). Modem shows RSSI based on its mode of operation, eg. Master or Slave.

Values (dBm)

-120 to -55dBm

S226 (NB Modems) Compatibility Type

The main purpose of this register is to fit receiving signal from different producers using 4FSK modulation scheme.

See tables in *Section 3* to find the correct settings listed by supported models.

Please contact our technical support team if you have radio compatibility problems, we are working on extending of the list of compatible modes

Values

0 - Original Mode: Type 0
 1 - Compatible Mode: Type 1
 2 - Compatible Mode: Type 2

S227 (NB - Trimtalk 450s) Trimtalk Comp. Type.

This register is used to allow the SDR400 to be compatible with Trimtalk radio's from different producers.

See tables in *Section 3* to find the correct settings listed by supported models.

Please contact our technical support team if you have radio compatibility problems, we are working on extending of the list of compatible modes

Values

0 - Original Trimtalk 450s: Type 0
 1 - Compatible Trimtalk 450s: Type 1

S228 (NB Modems) Call Sign ID

Call Sign ID for Automatic Station Identification (for NB modems).

- Empty(default). Call Sign ID will not be sent.
- Up to 16 Capital Letters or Digits. Call Sign ID will be Sent with Call Sign Interval (S233).

Entered Small Letters will be Converted to Capital Letters.

Values

(empty)

S231 (NB - MH Transparent/PCC Protocols) Data Buffering Mode

This register is to select the mode of outputting received data to the user interface: Packet Buffered and Not Buffered. Packet Buffered Output will not output any data until the CRC is checked for each packet. The latter will output data based on CRC checking for small data block within a packet.

Values

0 Not Buffered
 1 Packet Buffered

6.0 Register/Command Reference

S233 (NB Modems) Call Sign Interval

Call Sign Interval (for NB modems) in minutes (1-30). Default - 15 minutes. Used with S228, Call Sign ID.

Values (minutes)

15

S238 (FH Modems) Hopping Mode

Hopping mode register (S238) is preset by manufacturer. It is a read-only register for the end user. S238 controls the modem either hopping on pattern or on frequency table.

Values

0 - Hopping on pattern
 1 - Hopping on frequency table
 2 - Hopping on channel
 3 - Hopping on frequency

S244 (FH Modems) Channel Request Mode

Channel Request Mode 'on' (default), allows a Remote modem which has data to send to request from the Master permission to do so. When granted, the Remote will be allowed to transmit all of its data (no other Remotes may transmit during this period), upon completion of which it will release the channel. This feature eliminates collisions which would otherwise occur if a number of Remotes were all trying to transmit at the same time.

TDMA mode is discussed in detail in previous sections. It relates to Channel Requests in that, in TDMA mode, the Master does not allow such requests from Remotes; the Master sequences through a list of Remotes, giving each one in turn an opportunity to transmit.

Values

0 **Channel Request**
 1 TDMA Mode (Standard)

S248 (FH Modems) Sync Timeout

This register defines how many hop intervals where the slave does not receive a synchronization packet from the master, before it will become unsynchronized and begins to search for a master.

Values

1-65534
 512

S251 (FH Modems) Master Hop Allocation Timeout

In TDMA mode (see S244) this register determines how long, in hop intervals, the Master will wait for a Remote to either (a) begin to send data or (b) indicate that it has completed sending all of its data, prior to the Master sequencing to the next Remote to be given permission to transmit.

Values

hops
 1-254
 10

6.0 Register/Command Reference

6.3 Serial Interface Commands

A number of register settings are specifically related to the serial data interface. Some, which have been discussed previously, include:

S102 Serial Baud Rate	determines the rate of communications between the modem and the local device
S110 Data Format	defines the data, stop, and parity bit count

Also, there are AT commands which effect the configuration of the module, specifically with respect to the handling of data at the RS-232 interface:

- &C Data Carrier Detect (DCD)**
- &D Data Terminal Ready (DTR)**
- &K Handshaking**
- &S Data Set Ready (DSR)**

&Cn	Data Carrier Detect (DCD)		
Controls the module's DCD output signal to the attached device. Determines when the DCD line is active.	<table border="1"> <tr> <th style="background-color: #e0e0e0;">Values</th> </tr> <tr> <td>0 - DCD always on 1 - DCD on when synchronized (FH), when channel is idle (NB) 4 - DCD on when synchronized (FH), when channel is busy (NB)</td> </tr> </table>	Values	0 - DCD always on 1 - DCD on when synchronized (FH), when channel is idle (NB) 4 - DCD on when synchronized (FH), when channel is busy (NB)
Values			
0 - DCD always on 1 - DCD on when synchronized (FH), when channel is idle (NB) 4 - DCD on when synchronized (FH), when channel is busy (NB)			
&Dn	Data Terminal Ready (DTR)		
Controls the action that the module will perform when the DTR input line's state is modified.	<table border="1"> <tr> <th style="background-color: #e0e0e0;">Values</th> </tr> <tr> <td>0 - DTR ignored 2 - DTR disconnects and switches to command mode</td> </tr> </table>	Values	0 - DTR ignored 2 - DTR disconnects and switches to command mode
Values			
0 - DTR ignored 2 - DTR disconnects and switches to command mode			
&Kn	Handshaking		
Enables or disables hardware handshaking.	<table border="1"> <tr> <th style="background-color: #e0e0e0;">Values</th> </tr> <tr> <td>0 Handshaking disabled 1 CTS Control Transmitter of RS485 driver chip. 3 RTS/CTS handshaking enabled</td> </tr> </table>	Values	0 Handshaking disabled 1 CTS Control Transmitter of RS485 driver chip. 3 RTS/CTS handshaking enabled
Values			
0 Handshaking disabled 1 CTS Control Transmitter of RS485 driver chip. 3 RTS/CTS handshaking enabled			
&Sn	Data Set Ready (DSR)		
Controls the module's DSR line and determines when it is active.	<table border="1"> <tr> <th style="background-color: #e0e0e0;">Values</th> </tr> <tr> <td>0 - DSR always on 1 - DSR = 0 in data mode, 1 command mode</td> </tr> </table>	Values	0 - DSR always on 1 - DSR = 0 in data mode, 1 command mode
Values			
0 - DSR always on 1 - DSR = 0 in data mode, 1 command mode			



Software flow control (XON/XOFF) is not supported.

7.0 Installation

There are a number of factors to consider when preparing to deploy a radio network, several of which have been touched-upon or detailed elsewhere within this manual. Following is a listing of a number of factors, in no particular order:



The installation, removal, or maintenance of any antenna system components must be undertaken only by qualified and experienced personnel.

Network Topology

The SDR400 currently supports 400 MHz Licensed, Narrowband mode, 900 MHz ISM FHSS modes and 400 MHz Frequency Hopping (on table) modes. Within these modes the SDR400 supports various Point-to-Point and Point-to-Multipoint topologies.

Throughput

The SDR400 is capable of up to 345 kbps asynchronous baud rate. The network topology has an effect on how this available throughput is 'shared' between all nodes on the network.

Distance

The physical distance between the modems dictates such things as required antenna performance and heights. When contemplating antenna types, keep in mind the directivity (omnidirectional or directional) of the antennas being used.

Terrain

Along with distance, the terrain is a very important consideration with respect to antenna height requirements. The term 'line-of-sight' (LOS) refers to being able to 'see' one location from another - a minimum requirement for a radio signal path. In addition to LOS, adequate clearance must also be provided to satisfy 'Fresnel Zone' requirements - an obstruction-free area much greater than the physical LOS, i.e. LOS is not enough to completely satisfy RF path requirements for a robust communications link.

Transmit Power

Having read thus far through the factors to be considered, it should be clear that they are all interrelated. Transmit power should be set for the minimum required to establish a reliable communications path with adequate fade margin. Required transmit power is dictated primarily by distance, antenna type (specifically the 'gain' of the antennas being used), and the receive sensitivity of the distant modem. Cable and connector losses (the physical path from the modem's 'antenna connector' to the antenna's connector) must also be taken into account.

Receive Sensitivity

The SDR400 has exceptional receive sensitivity, which can produce a number of benefits, such as: added fade margin for a given link, being able to use less expensive coaxial cable or antenna types, being able to operate at greater distances for a given distant transmitter power (perhaps negating the requirement for a Repeater site!). Distance, antenna gain, transmit power, and receive sensitivity are critical 'numbers' for radio path calculations. Fortunately, the SDR400 Series features the maximum available transmit power combined with exceptional receive sensitivity - two 'numbers' which will produce the most favorable path calculation results.

7.0 Installation

Fade Margin

When all radio path numbers are being considered and hardware assumptions are being made, another factor to consider is the 'fade margin' of the overall system. The fade margin is the difference between the anticipated receive signal level and the minimum acceptable receive level (receive sensitivity). Being that the SDR400 Series performs to exacting specifications, the overall deployment should be such that the modems may be utilized to their full potential to provide a reliable and robust communications link. A typical desired fade margin is in the order of 20dB, however oftentimes a 10dB fade margin is acceptable.

Frequency

The frequency ranges supported are not effected by rain to any significant degree, and is also able to penetrate through foliage and 'around obstacles' to a certain degree. This being the case, some may choose to scrimp on the physical deployment, particularly when it comes to antenna (tower) heights. Path calculations provide results which specify 'required' antenna heights. For cost savings and in taking advantage of the characteristics of the frequency range, sometimes the height requirements are not adhered to: this may result in unreliable communications.

Power Requirements

The SDR400 Series may be integrated into a system (Development Board, or custom) which accepts a range of DC input voltages (supply current requirements must also be met). In some deployments, power consumption is critical. A number of features related to minimizing power consumption are available with the SDR400 such the ability to operate at lower transmit power given the receive sensitivity of the distant modem.

Interference

The frequency hopping spread spectrum (FHSS) operation of the SDR400 Series most often allows it to work well in an environment within which there may be sources of in-band interference. Frequency Restriction (Hopping Zones) is a built-in feature which may be utilized to avoid specific frequencies or ranges of frequencies; the Spectrum Analyzer function may be used to identify areas of potential interference. Cavity filters are also available if required: contact Microhard Systems Inc. for further information.

7.0 Installation

7.1 Path Calculation



FCC regulations allow for up to 36dBi effective isotropic radiated power (EIRP). The sum (in dBm) of the transmitted power, the cabling loss, and the antenna gain cannot exceed 36dBi.

Assuming adequate antenna heights, a basic formula to determine if an adequate radio signal path exists (i.e. there is a reasonable fade margin to ensure reliability) is:

$$\text{Fade Margin} = \text{System Gain} - \text{Path Loss}$$

where all values are expressed in dB.

As discussed on the previous page, a desired fade margin is 20dB.

System gain is calculated as follows:

$$\text{System Gain} = \text{Transmitter Power} + (\text{Transmitter Antenna Gain} - \text{Transmitter Cable and Connector Losses}) + (\text{Receiver Antenna Gain} - \text{Receiver Cable and Connector Losses}) + |\text{Receiver Sensitivity}|$$

where all values are expressed in dB, dBi, or dBm, as applicable.

Assuming a path loss of 113dB for this example, the fade margin = 143-113 = 30dB.

30dB exceeds the desired fade margin of 20dB, therefore this radio communications link would be very reliable and robust.

On the following page are examples of actual path loss measurements taken in an open rural environment; the path loss numbers do not apply to urban or non-LOS environments.

Example:

Tx power = 30dBm
Tx antenna gain = 6dBi
Tx cable/connector loss = 2dB
Rx antenna gain = 3dBi
Rx cable/connector loss = 2dB
Rx sensitivity = -108dBm

$$\begin{aligned} \text{System Gain} &= [30+(6-2)+(3-2)+108]\text{dB} \\ &= [30+4+1+108]\text{dB} \\ &= 143\text{dB}. \end{aligned}$$

7.0 Installation



To satisfy FCC radio frequency (RF) exposure requirements for mobile transmitting devices, a separation distance of 23cm or more should be maintained between the antenna of this device and persons during device operation. To ensure compliance, operation at less than this distance is not recommended. The antenna used for this transmitter must not be co-located in conjunction with any other antenna or transmitter.



Never work on an antenna system when there is lightning in the area.

Distance (km)	Master Height (m)	Remote Height (m)	Path Loss (dB)
5	15	2.5	116.5
5	30	2.5	110.9
8	15	2.5	124.1
8	15	5	117.7
8	15	10	105
16	15	2.5	135.3
16	15	5	128.9
16	15	10	116.2
16	30	10	109.6
16	30	5	122.4
16	30	2.5	128.8

Table 5-1: Path Loss (900 MHz)

Once the equipment is deployed, average receive signal strength may be determined by accessing S Register 123.

7.2 Installation of Antenna System Components

The installation, removal, or maintenance of any antenna system components must be undertaken only by qualified and experienced personnel.

7.2.1 Antennas

The two most common types of antenna are the omnidirectional ('omni') and directional (Yagi).

An **omni** typically has 3-6dBi gain and spreads its energy in all directions (hence the name 'omnidirectional'). The 'pattern' of the energy field is in the shape of a donut, with the antenna mounted vertically at the centre. This vertical-mounted antenna produces a signal which is vertically 'polarized'.

A **Yagi** has a more focused antenna pattern, which results in greater gain: commonly, 6-12dBi. The pattern of a Yagi is in the shape of a large raindrop in the direction in which the antenna is pointed. If the elements of the Yagi are perpendicular to the ground (most common orientation) the radiated signal will be vertically polarized; if parallel to the ground, the polarization is horizontal.

The network topology, application, and path calculation are all taken into consideration when selecting the various antenna types to be used in a radio network deployment.

7.0 Installation



Direct human contact with the antenna is potentially unhealthy when a SDR400 is generating RF energy. Always ensure that the SDR400 equipment is powered down (off) during installation.



To comply with FCC regulations, the maximum EIRP must not exceed 36dBm.



All installation, maintenance, and removal work must be done in accordance with applicable codes.

7.2.2 Coaxial Cable

The following types of coaxial cable are recommended and suitable for most applications (followed by loss at 900MHz, in dB, per 100 feet):

- LMR 195 (10.7)
- LMR 400 (3.9)
- LMR 600 (2.5)

For a typical application, LMR 400 may be suitable. Where a long cable run is required - and in particular within networks where there is not a lot of margin available - a cable with lower loss should be considered.

When installing cable, care must be taken to not physically damage it (be particularly careful with respect to not kinking it at any time) and to secure it properly. Care must also be taken to affix the connectors properly - using the proper crimping tools - and to weatherproof them.

7.2.3 Surge Arrestors

The most effective protection against lightning-induced damage is to install two lightning surge arrestors: one at the antenna, the other at the interface with the equipment. The surge arrestor grounding system should be fully interconnected with the transmission tower and power grounding systems to form a single, fully integrated ground circuit. Typically, both ports on surge arrestors are N-type female.

7.2.4 External Filter

Although the SDR400 Series is capable of filtering-out RF noise in most environments, there are circumstances that require external filtering. Paging towers and cellular base stations in close proximity to the SDR400's antenna can desensitize the receiver. Microhard Systems Inc.'s external cavity filter eliminates this problem. The filter has two N-female connectors and should be connected inline at the interface to the RF equipment.

Appendix A: AT Command Quick Reference

The following commands may be used when the modem is in COMMAND MODE; all are to be preceded with "AT" and followed with [Enter]. An asterisk (*) indicates a default setting, where applicable.

A

Answer

-this command puts the modem into online/data mode

g, G

Spectrum Analyzer

Used to help determine if interfering RF signals are present.

In

Identification

-follow ATi with either of the following 'n':

- 1-product code
- 3-firmware version
- 4-firmware date
- 5-firmware copyright
- 6-firmware time
- 7-Serial Number
- 255-factory-configured options listing

N

Advanced Spectrum Analyzer

Advanced spectrum analyzer provides for a more detailed scrutiny of the RF environment.

&Fn

Load Factory Default Configuration

Frequency Hopping Modems

- &F1 - FH Master Fast PMP
 - &F2 - FH Slave Fast PMP
 - &F3 - FH Repeater Fast PMP
 - &F4 - FH Master Slow PMP
 - &F5 - FH Slave Slow PMP
 - &F6 - FH Master Fast PP
 - &F7 - FH Slave Fast PP
 - &F8 - FH Master Slow PP
 - &F9 - FH Slave Slow PP
 - &F10 - FH Master Fast PMP no Time ACK
 - &F11 - FH Master Fast P2P no Time ACK
 - &F12 - FH Master Fast PP no Time ACK
 - &F15 - FH Master WL
 - &F16 - FH Slave WL
 - &F18 - FH Master Fast TDMA
 - &F19 - FH Slave Fast TDMA
- Narrow Band (NB) modems
- &F51 - NB Transparent Protocol
 - &F52 - NB Transparent Protocol w Rep.
 - &F53 - NB Pacific Crest Protocol, needs different UAs
 - &F54 - NB Trimtalk Protocol no Rep.
 - &F55 - NB Trimtalk Protocol Rep.1
 - &F56 - NB Trimtalk Protocol Rep.2
 - &F57 - NB Trimtalk Protocol Base w Rep.
 - &F58 - NB 3AS Protocol, SRate=9.6kbps, BW=12.5kHz
 - &F59 - NB 3AS Protocol, SRate=19.2kbps, BW=25kHz

&F100 - Reset Hopping Modes

&Cn

DCD (Data Carrier Detect)

- controls modem's DCD output signal
- 0-DCD always on
- 1-DCD on when modem's sync'ed, always on if Master*

&Dn

DTR (Data Terminal Ready)

- controls the action the modem performs when the DTR input line is toggled
- follow ATD with either of the following 'n':
- 0-*DTR line ignored
- 2-deassert DTR to force modem from data mode into command mode at S102 serial baud rate; DTR must be asserted before putting modem back into data mode (normally done using 'ATA' command)

&Kn

Handshaking

- determines handshaking between modem and host device
- 0-disable handshaking
- 3-enable hardware (RTS/CTS) handshaking*

&Sn

DSR (Data Set Ready)

- controls modem's DSR line and determines when it is active
- 0-DSR always on
- 1-*DSR ON in data mode, OFF in command mode

AT&V

View Configuration

-displays all visible S registers and their current values

&W

Write Configuration to Memory

-stores active configuration into modem's non-volatile memory

Sxxx?

Read S Register Value

-where xxx is the S register's number, this command will result in displaying the current setting of that register

Sxxx=yyy

Set S Register Value

-where xxx is the S register's number, this command will place value yyy in that register

Sxxx /?

Display S Register Help Text

-where xxx is the S register's number, this command will result in displaying the available settings of that register. Not all registers have help text.

Appendix B: Settings (S) Register Quick Reference

The registers described in this Appendix are ones which are normally 'visible' to the user. The values stored in these registers effect the operation of the modem. An asterisk * represents default value (if applicable).

Query format : **ATSxxx? [Enter]** where xxx is S register *number* detailed below
Change format : **ATSxxx=y [Enter]** where xxx is S register number and y is desired value

S101

Operating Mode

For FH modems

- 0 - Master
- 1 - Repeater
- 2 - Remote

For NB modems (depends on selected protocol)

- 0 - Master (Base) for Trintalk
- 1 - Repeater
- 2 - Slave (Remote)
- 3 - Repeater 2 for Trintalk

S102

Serial Port Baud Rate (bps)

- | | |
|------------|-----------|
| • 0-230400 | • 8-7200 |
| • 1-115200 | • 9-4800 |
| • 2-57600 | • 10-3600 |
| • 3-38400 | • 11-2400 |
| • 4-28800 | • 12-1200 |
| • 5-19200 | • 13-600 |
| • 6-14400 | • 14-300 |
| • 7-9600 | |

S103

Wireless Link Rate (bps)

Frequency Hopping modems:

- 0 - 19200
- 1 - 115200
- 2 - 172800
- 3 - 230000
- 4 - 247000
- 5 - 340000
- 6 - 24700
- 8 - 57600

Narrow Band modems:

- 0 - 1200
- 1 - 2400
- 2 - 3600
- 3 - 4800
- 4 - 7200
- 5 - 9600
- 6 - 14400
- 7 - 19200
- 8 - 16000

S104

Network Address

- 0-4,000,000,000
- 1234567890*

S105

Unit Address

- 1-65534

S108

Output Power Level

- 20-30dBm
- 30* (1W)

S110

Data Format (of Asynchronous serial input to modem)

- | | |
|----------|----------|
| • 1-8N1* | • 6-7N2 |
| • 2-8N2 | • 7-7E1 |
| • 3-8E1 | • 8-7O1 |
| • 4-8O1 | • 9-7E2 |
| • 5-7N1 | • 10-7O2 |

S113 - Packet Retransmissions

0-255

5*

S115 - Repeat Interval

0-255

1*

S123

RSSI Value (dBm, read only)

S133 (FH Modems)

Network Type

- 0 - Point to Multipoint
- 1 - Point to Point
- 2 - Peer to Peer
- 3 - Reserved
- 4 - PMP with acks

S140

Destination Address

1-65535, where 65535 = Broadcast

S158

FEC Mode

- 0 No FEC
- 1 Hamming (7,4)
- 2 Hamming (15,11)
- 3 Hamming (31,24)
- 5 Binary BCH (47,36)
- 6 Golay (23,12,7)
- 7 Reed-Solomon (15,11)*

S244

Channel Access Mode

- 0 - Channel request (default),
- 1 - TDMA,
- 2 - Fast TDMA
- 3 - On GPS index,
- 4 - Adaptive TDMA

Appendix C: AT Utility Firmware Upgrade Procedure

To update the firmware, it is recommended to use the Microhard Utility called **AT Firmware Upgrade**. This utility is available for download from the Microhard Support Site below:

<http://www.microhardcorp.com/support>

To access the downloads section of the support site, you must first register, if you have not already done so.

1. Power up the Modem and Connect a straight through serial cable to the DATA Port of the module. (If installed in development board).
2. Run the utility downloaded from the Microhard Support site.

“ATFirmwareUpgrade.exe”

3. Select the COM port on your PC that is connected to the Module.
4. Browse to the firmware file supplied by Microhard Systems. (.img) to be uploaded to the module.
5. Click the “Load” button. *If a password was setup using the ATlogin command, you will be prompted for this password before you can update the firmware.*
6. The utility will establish a connection to the module and load the firmware. Once complete, a message will display at the bottom of the utility window indicating that the process succeeded.

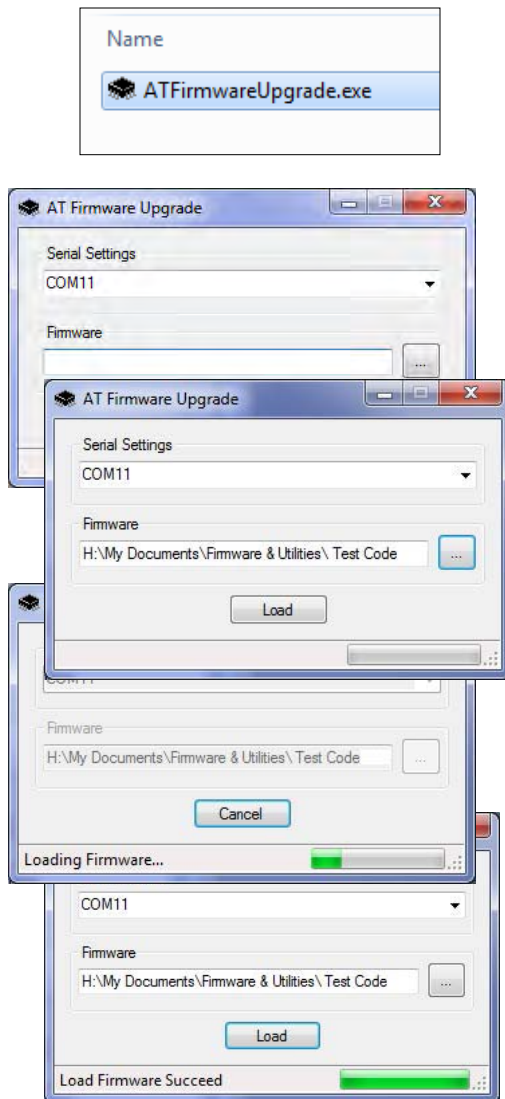

Image C-1: Firmware Upgrade

Appendix D: AT Command Firmware Upgrade Procedure

To update the firmware on the SDR400 Series Radio, it is recommended to use the Microhard Utility called **AT Firmware Upgrade**, discussed on the previous page. If it is not possible to use the utility, the following procedure can be used to load firmware using AT commands. The file type used for this procedure is not the same as when using the utility. A file must be supplied by Microhard Systems with the .svg extension.

AT Command Upgrade Procedure

1. Enter Command Mode.
2. Select the baud rate 115200 bps (ATS102=1) for the modem to minimize the firmware upgrade time. Connect Microhard modem through a COM port as the setting with serial port terminal software:

Baud Rate: 115200
Parity bit: None
Data bits: 8
Stop bits: 1
Flow Control: None

3. Run Microhard AT command to do the flash upgrade in the following sequence:

- 3.1 Run "at&u0<CR>" at command terminal

Initialize the modem into flash image upgrade mode

- 3.2 Run "at&u1<CR>" at command terminal

Load the flash image into the modem. After this command is entered, don't do anything except send the firmware file provided by Microhard (.svg). The Modem doesn't send ACK packets after receiving every data block; it sends "OK" response only when modem receives the last data block. It sends an "ERROR" response if the file was not received.

- 3.3 Run "at&u2<CR>" at command terminal

Pre-arm the image flashing. You have 20s to trigger the writing procedure of the firmware image from RAM to Flash memory. If you missed that window of opportunity, you need to pre-arm modem again.

- 3.4 Run "at&u3<CR>" at command terminal

Flash the loaded image. After this command has been issued, any action and power changes could damage the modem. Modem returns the "ERROR" response when the 20s time-out is expired. The approximate duration on this step is 30s.

After the flash upgrade finishes, the modem reboots and it is ready to work.

Appendix E: Development Board Serial Interface

Arrows denote the direction that signals are asserted (e.g., DCD originates at the DCE and tells the DTE that a carrier is present).

The SDR400 Serial Interface on the Development Board uses 8 pins on the header connector for asynchronous serial I/O. The interface conforms to standard RS-232 signals without level shifting, so direct connection to a host microprocessor is possible.

The signals in the asynchronous serial interface are described below:

Module (DCE)	Signal	Host Microprocessor (DTE)
1	DCD →	IN
2	RX →	IN
3	← TX	OUT
4	← DTR	OUT
5	SG	
6	DSR →	IN
7	← RTS	OUT
8	CTS →	IN

Table F1

DCD *Data Carrier Detect* - Output from Module - When asserted (TTL low), DCD informs the DTE that a communications link has been established with another n920.

RX *Receive Data* - Output from Module - Signals transferred from the n920 are received by the DTE via RX.

TX *Transmit Data* - Input to Module - Signals are transmitted from the DTE via TX to the n920.

DTR *Data Terminal Ready* - Input to Module - Asserted (TTL low) by the DTE to inform the module that it is alive and ready for communications.

SG *Signal Ground* - Provides a ground reference for all signals transmitted by both DTE and DCE.

DSR *Data Set Ready* - Output from Module - Asserted (TTL low) by the DCE to inform the DTE that it is alive and ready for communications. DSR is the module's equivalent of the DTR signal.

RTS *Request to Send* - Input to Module - A "handshaking" signal which is asserted by the DTE (TTL low) when it is ready. When hardware handshaking is used, the RTS signal indicates to the DCE that the host can receive data.

CTS *Clear to Send* - Output from Module - A "handshaking" signal which is asserted by the DCE (TTL low) when it has enabled communications and transmission from the DTE can commence. When hardware handshaking is used, the CTS signal indicates to the host that the DCE can receive data.

Notes: It is typical to refer to RX and TX from the perspective of the DTE. This should be kept in mind when looking at signals relative to the module(DCE); the module transmits data on the RX line, and receives on TX.

"DCE" and "module" are often synonymous since a module is typically a DCE device.

"DTE" is, in most applications, a device such as a host microprocessor.

Appendix F: SDR400 Development Board Schematic (1 of 2)

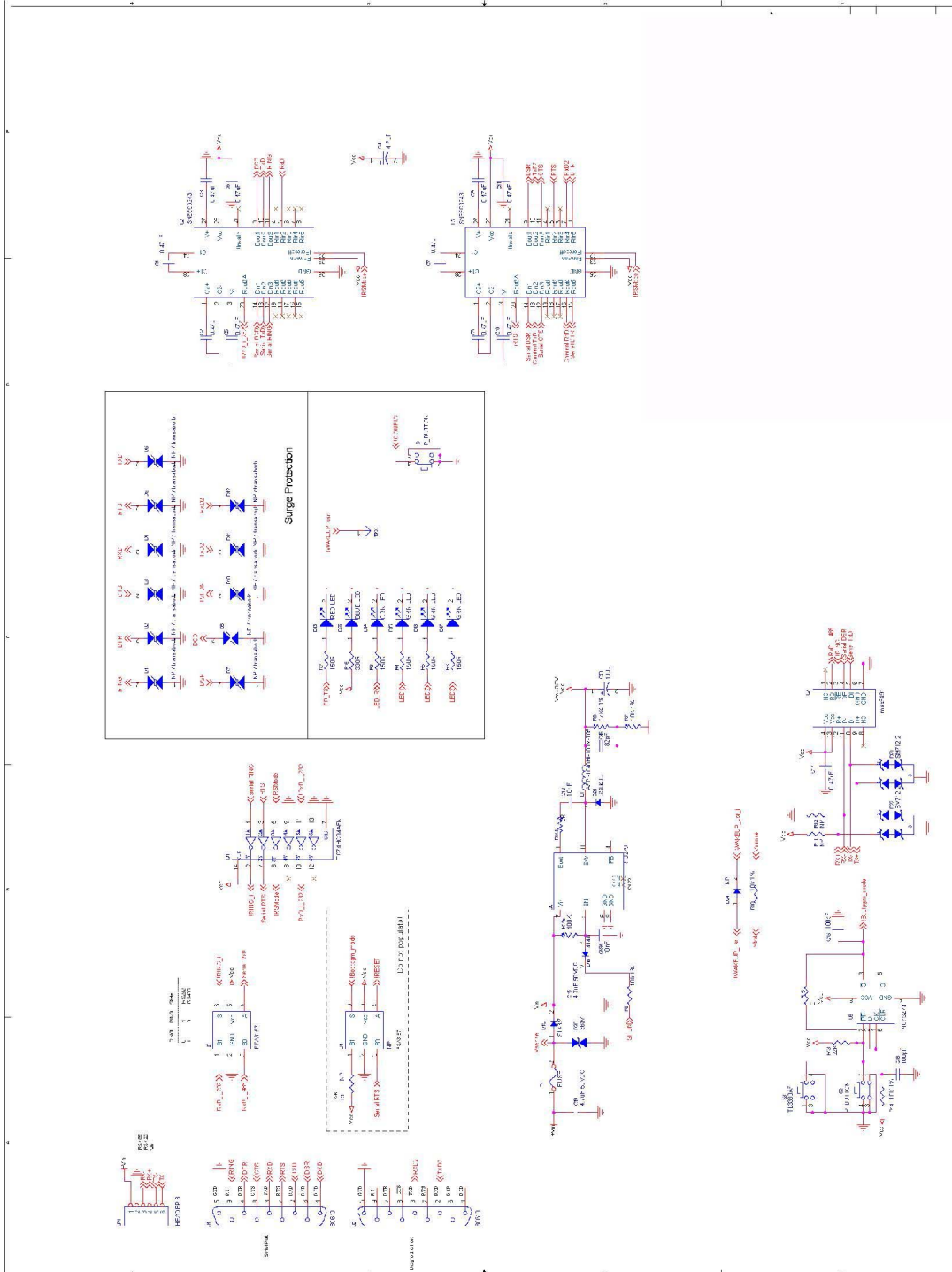

Appendix G: SDR400 Approved Antennas

Group	Part Number	Description
Rubber Ducky		
	MHS031000	2dBi, 900MHz Rubber Ducky Antenna RPTNC Swivel
	MHS031070	2dBi, 900MHz Rubber Ducky Antenna Reverse SMA Swivel
	MHS031080	2dBi, 900MHz Rubber Ducky Antenna Reverse SMA Straight
Transit Antennas		
	MHS031210	3dBd, 900 MHz Transit Antenna with Ground Plane
	MHS031220	3dBd, 900MHz Transit Antenna No Ground Plane
	MHS031230	3dBd, 900MHz Transit Antenna Permanent Mount GP
	MHS031240	3dBd, 900MHz Transit Antenna Permanent Mount NGP
<i>Mounts for Transit Antennas have a RPTNC Pigtail</i>		
Yagi Antennas		
	MHS031311	6dBd, 900MHz Yagi Directional Antenna Antenex, RPTNC Pigtail
	MHS031431	6.5dBd, 900MHz Yagi Directional Antenna Bluewave, RPTNC Pigtail
	MHS031501	9dBd, 900MHz Yagi Directional Antenna Antenex, RPTNC Pigtail
	MHS031441	10dBd, 900 MHz Yagi Directional Antenna Bluewave, RPTNC Pigtail
	MHS031451	11dBd, 900 MHz Yagi Directional Antenna Bluewave, RPTNC Pigtail
Patch Antennas		
	MHS031440	8dBi, 900 MHz, Patch Antenna, RPTNC Pigtail
Omni Directional		
	MHS031251	3dBd, 900MHz Omni Directional Antenna Antenex, RPTNC Pigtail
	MHS031461	3dBd, 900 MHz Omni Directional Antenna Bluewave, RPTNC Pigtail
	MHS031321	6dBd, 900MHz Omni Directional Antenna Antenex, RPTNC Pigtail
	MHS031471	6dBd, 900 MHz Omni Directional Antenna Bluewave, RPTNC Pigtail



WARNING:

Changes or modifications not expressly approved by Microhard Systems Inc. could void the user's authority to operate the equipment. This device has been tested with MMCX connectors with the antennas listed in Appendix A. When integrated in OEM products, fixed antennas require installation preventing end-users from replacing them with non-approved antennas. Antennas not listed in the tables must be tested to comply with FCC Section 15.203 (unique antenna connectors) and Section 15.247 (emissions). Please Contact Microhard Systems Inc. if you need more information.

Industry Canada: This device has been designed to operate with the antennas listed below, and having a maximum gain of 13.2 dBi. Antennas not included in this list or having a gain greater than 13.2 dBi are strictly prohibited for use with this device. The required antenna impedance is 50 ohms. To reduce potential radio interference to other users, the antenna type and its gain should be so chosen that the equivalent isotropically radiated power (EIRP) is not more than that required for successful communication. This Class B digital apparatus complies with Canadian ICES-003.

Under Industry Canada regulations, this radio transmitter may only operate using an antenna of a type and maximum (or lesser) gain approved for the transmitter by Industry Canada. To reduce potential radio interference to other users, the antenna type and its gain should be so chosen that the equivalent isotropically radiated power (e.i.r.p.) is not more than that necessary for successful communication.

This radio transmitter (identify the device by certification number, or model number if Category II) has been approved by Industry Canada to operate with the antenna types listed above with the maximum permissible gain and required antenna impedance for each antenna type indicated. Antenna types not included in this list, having a gain greater than the maximum gain indicated for that type, are strictly prohibited for use with this device.

Appendix H: Antenna / Separations

This relates to operation in 400MHz Licensed Band

Antenna	Impedance (ohms)	Antenna Gain (dBi)	Minimum Separation Distance (cm)
Minimum Gain	50	0	24
Maximum Gain	50	10	77

RF EXPOSURE DISTANCE LIMITS

$$r = \sqrt{\frac{P \cdot G}{4 \cdot \pi \cdot S}} = \sqrt{\frac{EIRP}{4 \cdot \pi \cdot S}}$$

Sample calculation:

$$S = 406.1/1500 \text{ mW/cm}^2$$

$$EIRP = 51 \text{ dBm} = 10^{55/10} \text{ mW} = 125893 \text{ mW (Worst Case)}$$

$$\text{(Minimum Safe Distance, r)} = \sqrt{\frac{EIRP}{4 \cdot \pi \cdot S}} = \sqrt{\frac{2000}{4 \cdot \pi \cdot (406.1/1500)}} \approx 76.7 \text{ cm}$$



WARNING:

Changes or modifications not expressly approved by Microhard Systems Inc. could void the user's authority to operate the equipment. Please Contact Microhard Systems Inc. if you need more information.



WARNING:

To satisfy FCC RF exposure requirements for mobile transmitting devices, a separation distance is based on the above them ranging from 24 cm to 77 cm between the antenna of this device and persons during device operation. To ensure compliance, operations at closer than this distance is not recommended. The antenna used for this transmitter must not be co-located in conjunction with any other antenna or transmitter.



Shenzhen Sinosun Technology Co.,Ltd.

Address: Room 3A17, South Cansong Building, Tairan Science Park, Futian District, Shenzhen City, Guangdong Province, P. R. China.

Johnson: +86 13902912908(Mobile&WeChat) +852 44017395(Mobile&WhatsApp) Tony: +86 13823678436(Mobile&WeChat)

Phone:+86 755 83849417 83435240 Fax:+86 755 83849434 Postcode: 518040

www.sinosun.cn E-mail:13823678436@139.com

2023.9.19